

Area	JAPAN	NORTH AMERICA	LATIN AMERICA	EUROPE	GENERAL AREA	CHINA
Model Name	KJ-65A9G	XBR-65A9G	XBR-65A9G	KD-65AG9	KD-65A9G	KD-65A9G
SV No.	SV-36282	SV-36278(UC2)	SV-36278(LA1)	SV-36285	SV-36287	SV-36281
DIMENSION	TV only (WxHxD)	144.7x83.4x4.0(0.62) cm	1447x834x40(6.2) mm / 57 x 32 7/8 x 1 5/8(1/4) inch	1447x834x40(6.2) mm	Approx. 144.7x83.4x4.0(0.62) cm	Approx. 1447x834x40(6.2) mm
	TV with Stand (WxHxD)	144.7x83.8x25.5 cm	1447x838x255 mm / 57 x 33 x 10 1/8 inch	1447x838x255 mm	Approx. 144.7x83.8x25.5 cm	Approx. 1447x838x255 mm
	Media Receiver (WxHxD)	-	-	-	-	-
	Monitor only (WxHxD)	-	-	-	-	-
	Monitor with Stand (WxHxD)	-	-	-	-	-
	Media Receiver with Stand (WxHxD)	-	-	-	-	-
	Satellite Speaker (WxHxD)	-	-	-	-	-
	Stand Width	47.0 cm	470 mm / 18 5/8 inch	470 mm	Approx. 47.0 cm	Approx. 470 mm
	VESA Hole Pitch	30.0x30.0 cm	300x300 mm / 11 7/8 x 11 7/8 inch	300x300 mm	30.0x30.0 cm	300x300 mm
WEIGHT	TV Only	21.2 Kg	21.2 Kg / 46.7 lb	21.2 Kg	Approx. 21.2 Kg	Approx. 21.2 Kg
	TV With Stand	24.8 Kg	24.8 Kg / 54.7 lb	24.8 Kg	Approx. 24.8 Kg	Approx. 24.8 Kg
	Media Receiver	-	-	-	-	-
	Monitor Only	-	-	-	-	-
	Monitor With Stand	-	-	-	-	-
	Media Receiver with Stand	-	-	-	-	-
	Satellite Speaker	-	-	-	-	-
Remarks						

TV WITH STAND

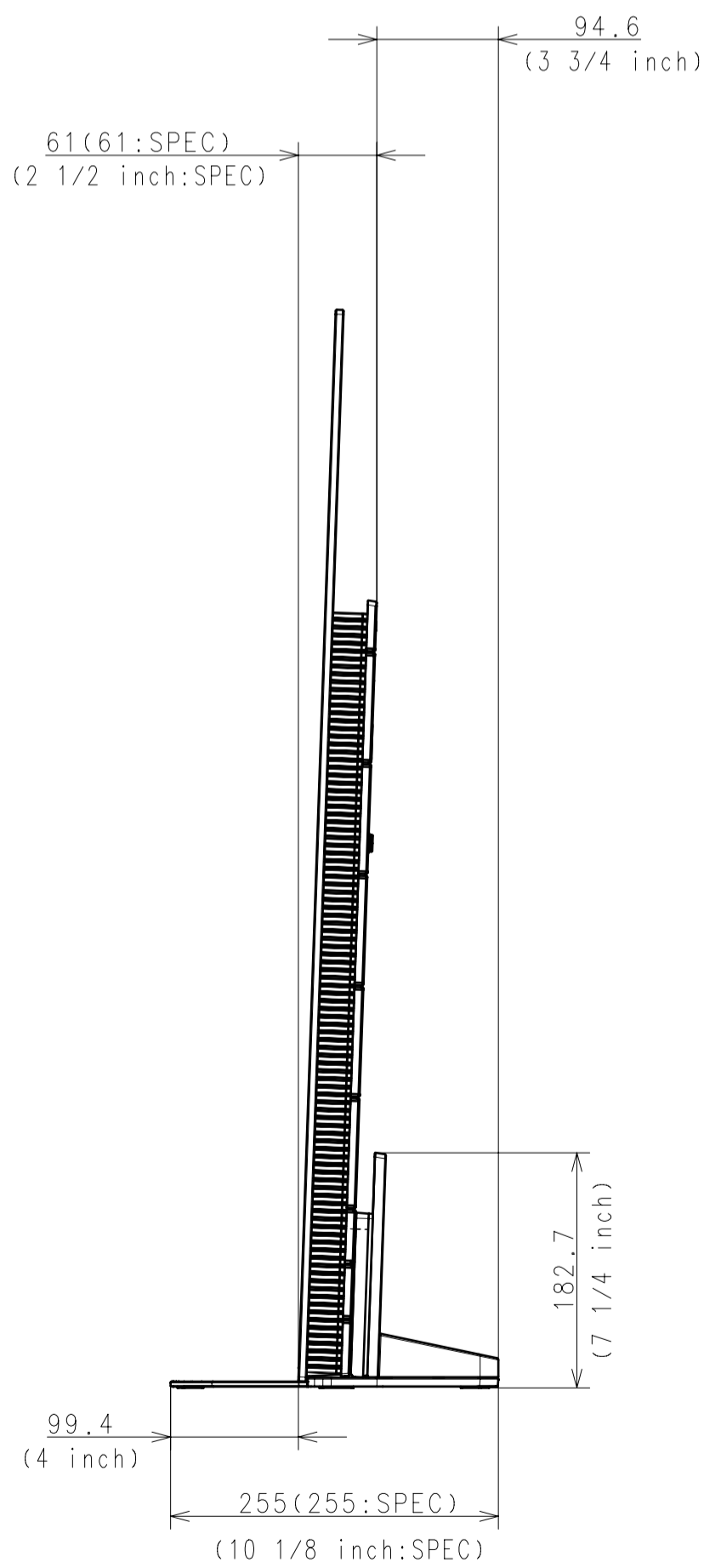

WITHOUT COVER

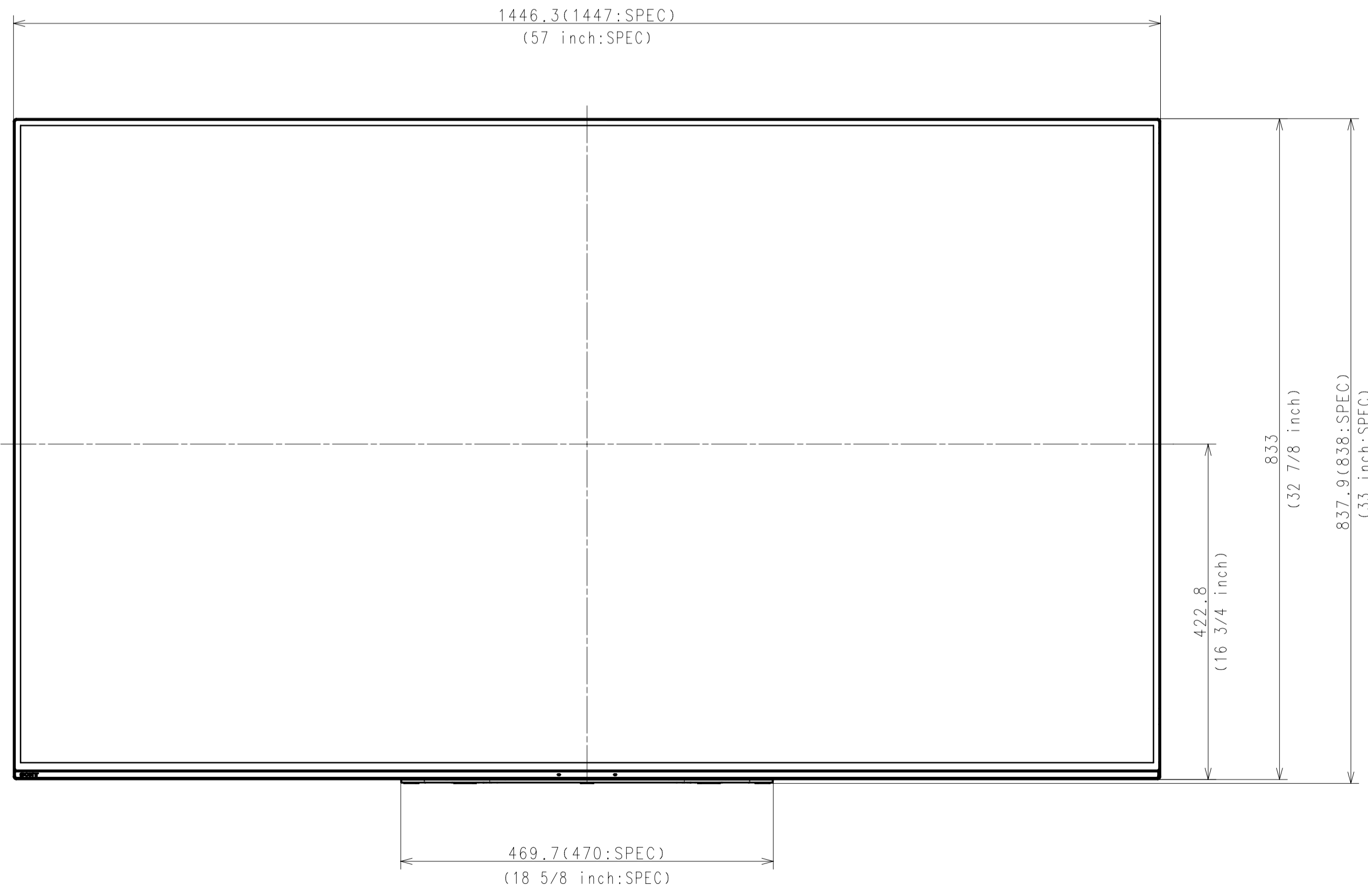
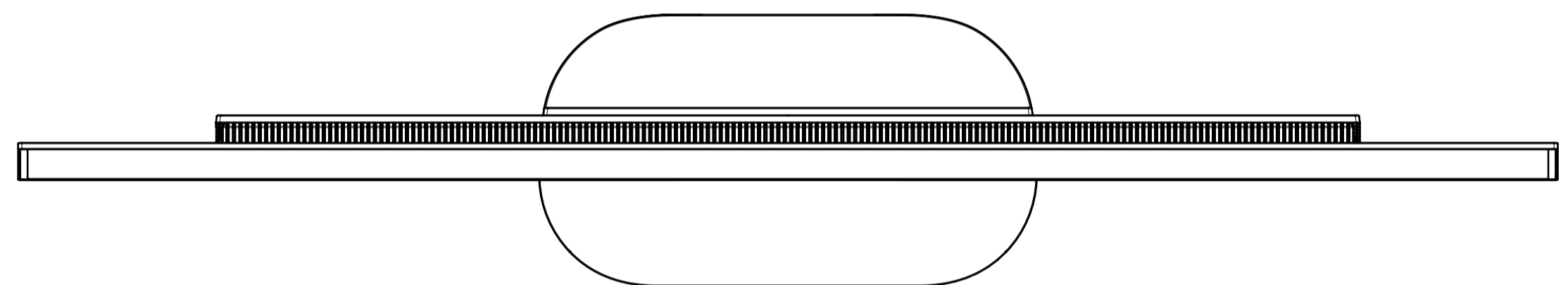
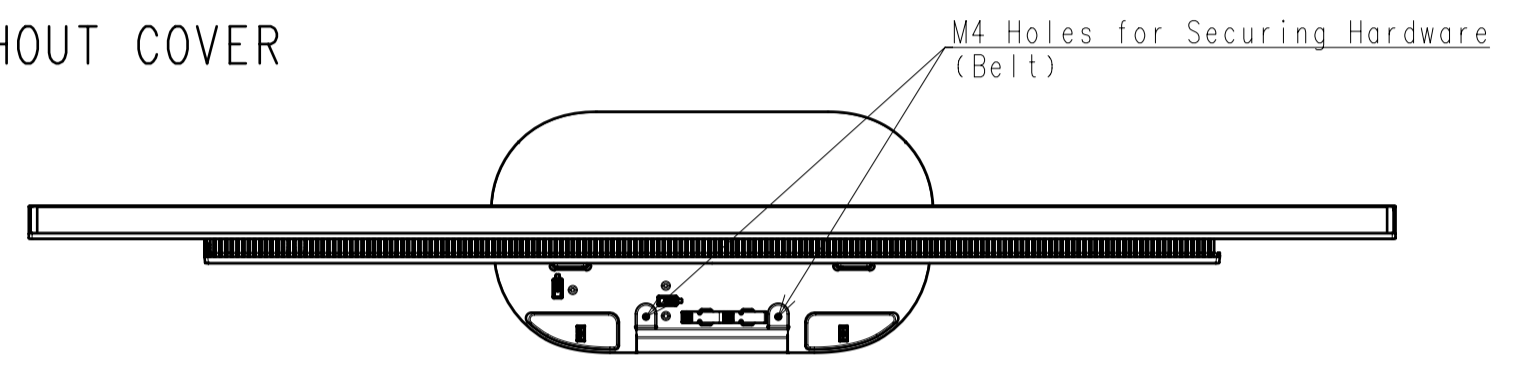

WITH COVER

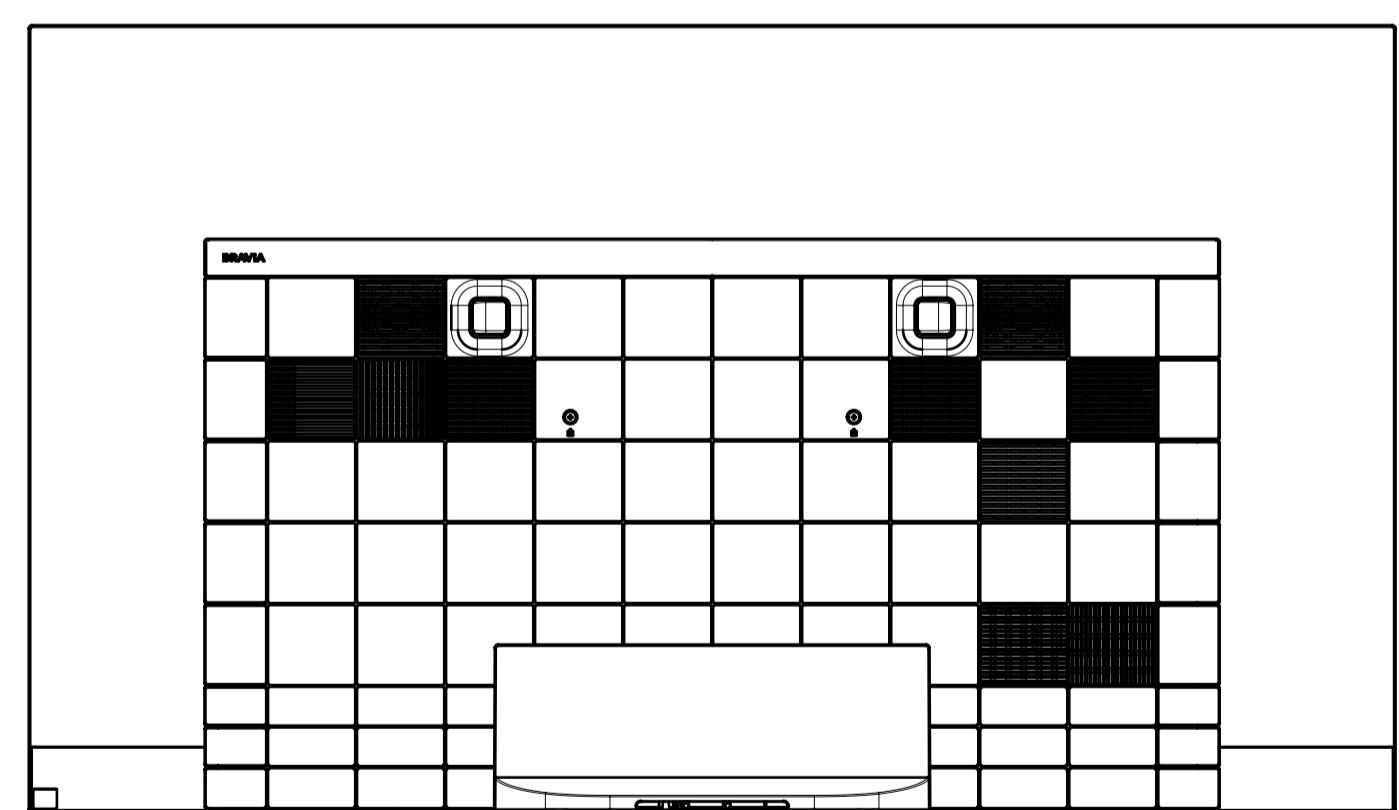
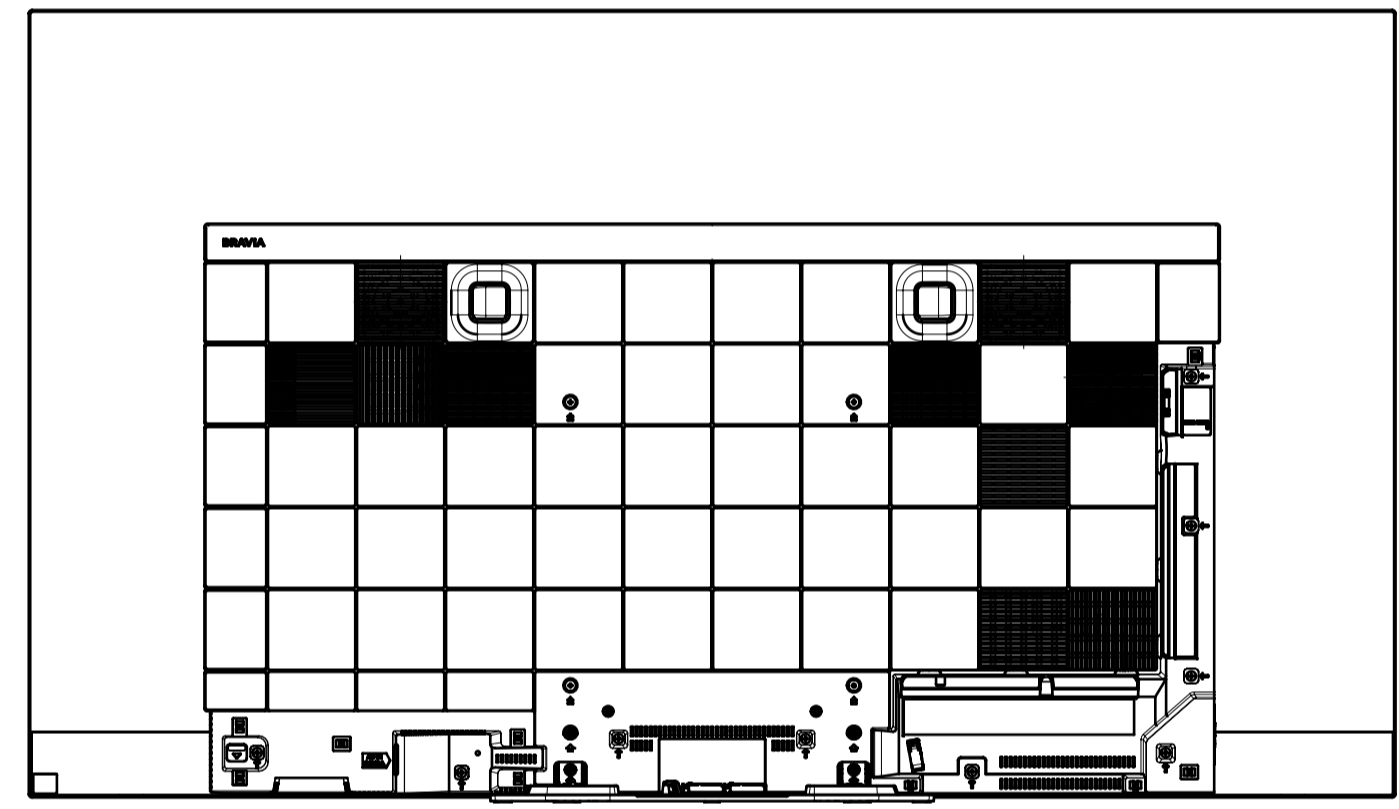

Purchase recycled resins and wire rods only from the business partners that Sony approves as Green Partners.
 再生樹脂・線材はグリーンパートナー認定品から調達すること。

△A △B △C △D △E △F △G △H △I △J △K △L	HISTORY V. COUNT SUFFIX PREL. NO. DATE RELEASE NO. DATE REVISION SIGN. LEGAL OWNER Sony Corporation	GENERAL TOLERANCE DATE OF ISSUE 2019.02.12 DOCUMENT TYPE PART TOLERANCING DRAWING (JIS 8 000(ISO 001)) MATERIAL COLOR FINISH/COLOR	RESPONSIBLE DEPARTMENT SVP-TV B Div. PD Div. PD Dept. 3 PLANNED BY 2019.02.12 K. NARASAKI DRAWN BY 2019.02.12 K. NARASAKI	ORIGINAL MODEL 65 (A9G) EXTERIOR VIEW TENTATIVE MODEL 65 (A9G) EXTERIOR VIEW SCALE 1:5 SIZE A1 UNIT mm PART NO. SUFFIX REV. NO. 1 / 3
--	---	---	--	--

TV WITHOUT STAND

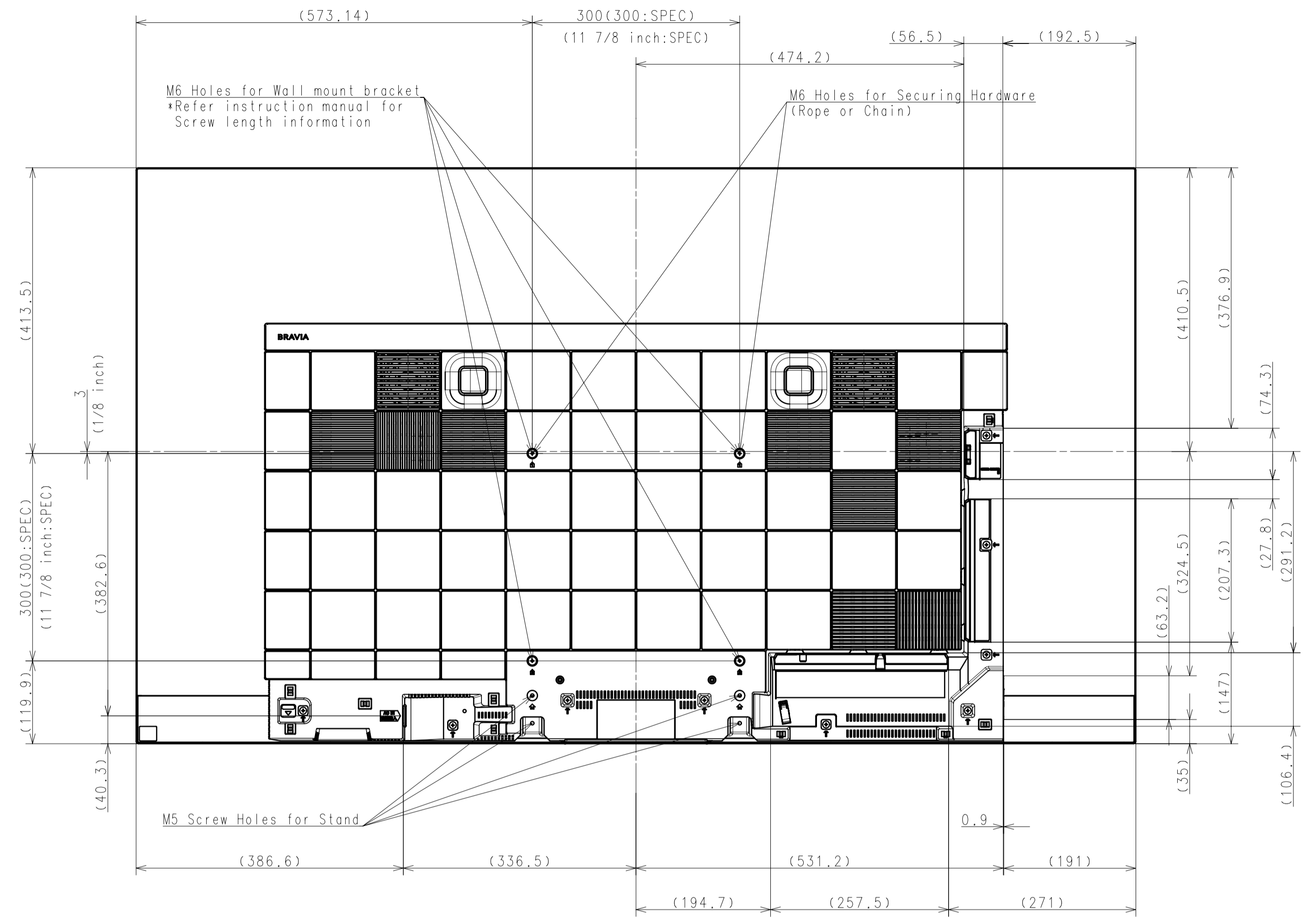
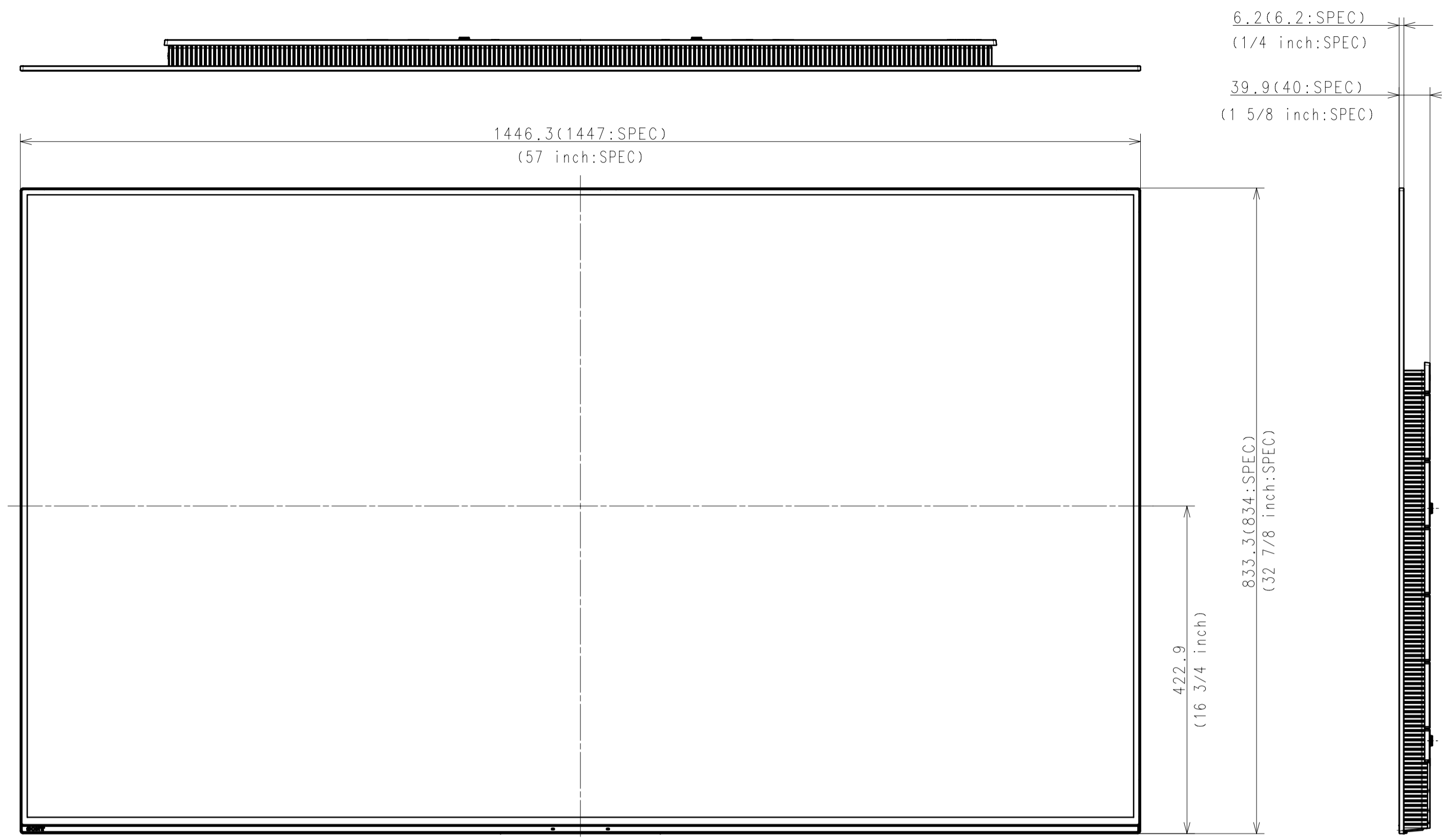

SU-WL450 SLIM

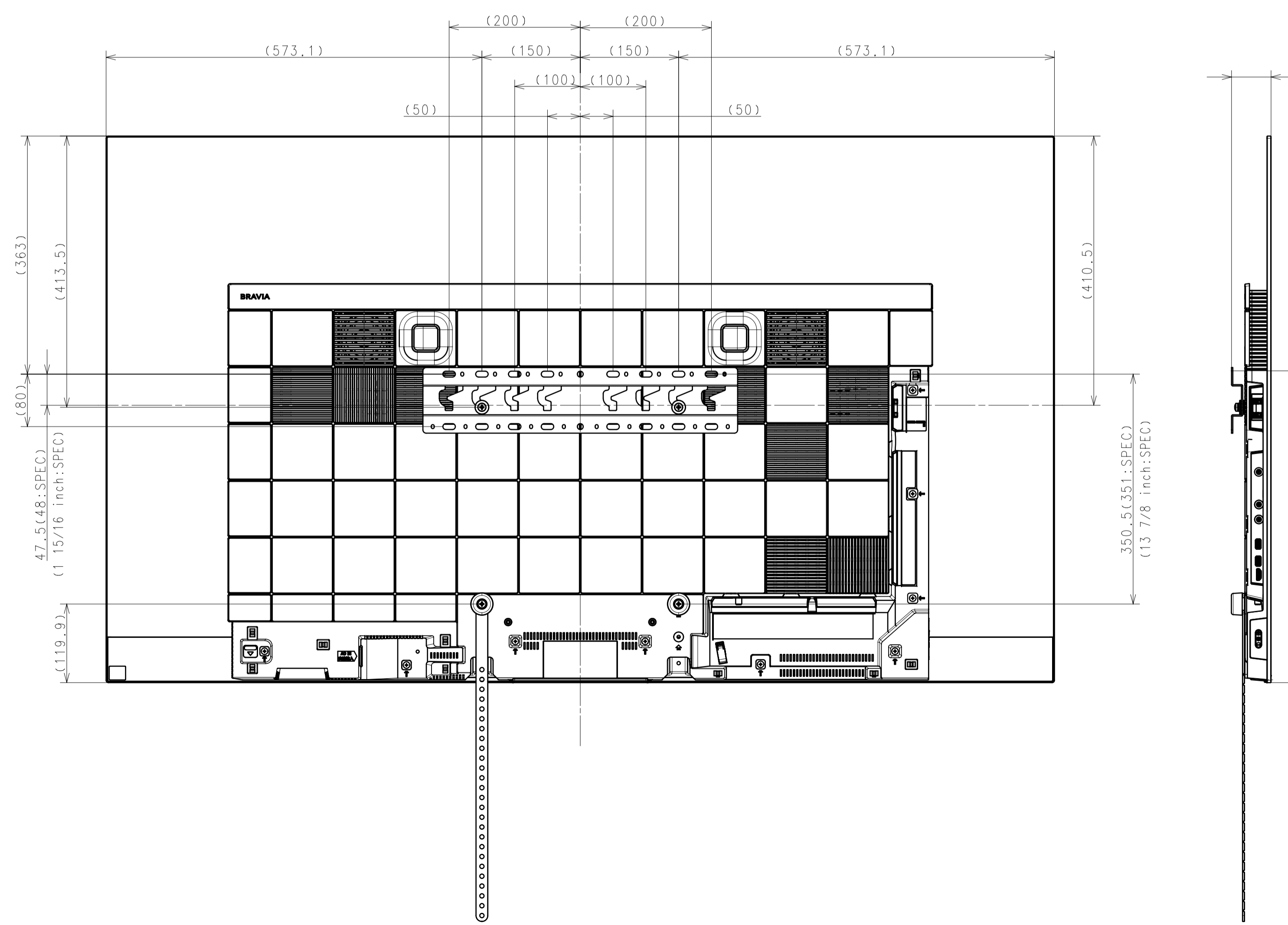

DESCRIPTION 1	65 (A9G) EXTERIOR VIEW	LEGAL OWNER	Sony Corporation	SCALE	1:5
DESCRIPTION 2	65 (A9G) EXTERIOR VIEW	PART NO.		SHEET/PAGES	2 / 3

SU-WL850

SU-WL855 WITH LATERAL SHAFT BRACKET

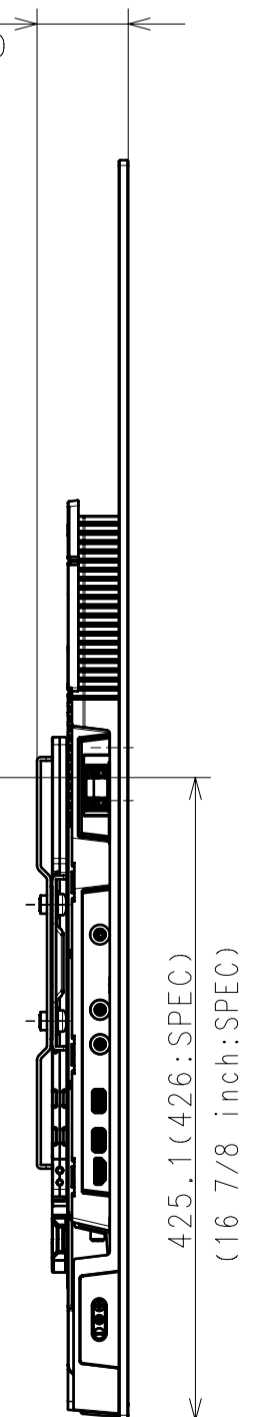
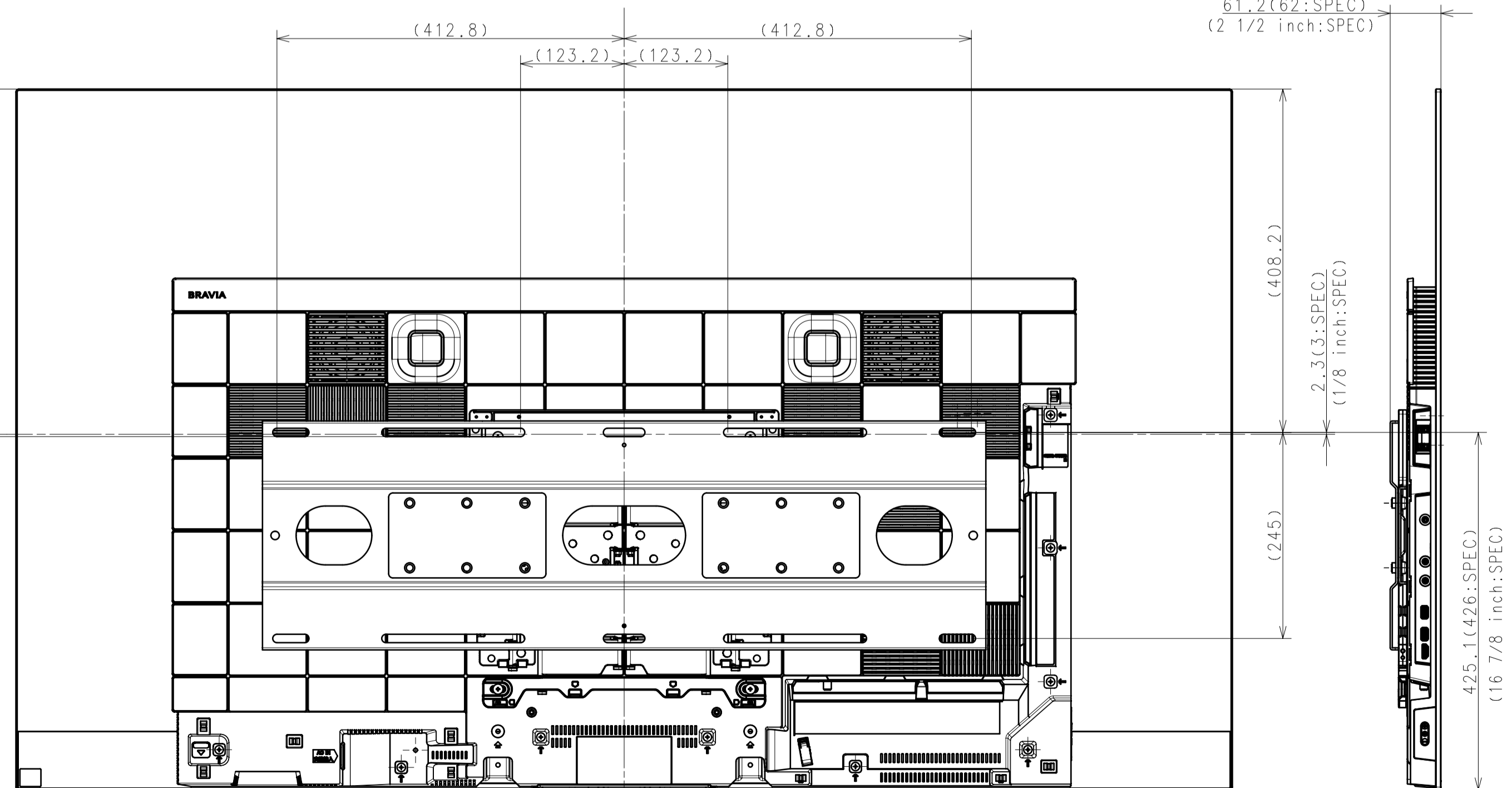
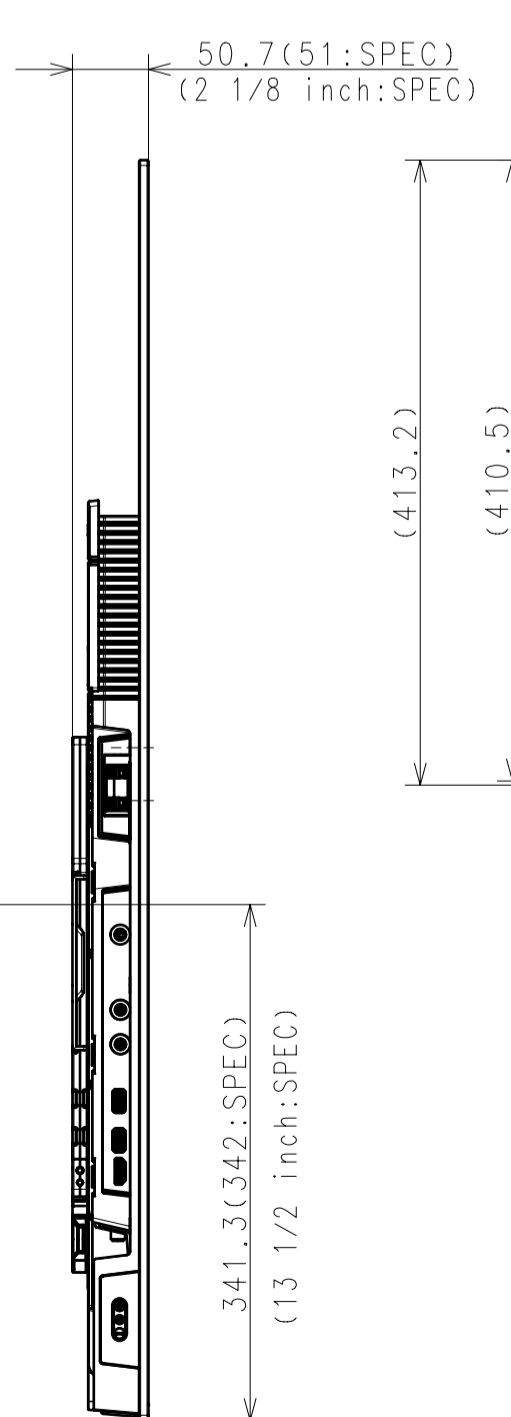
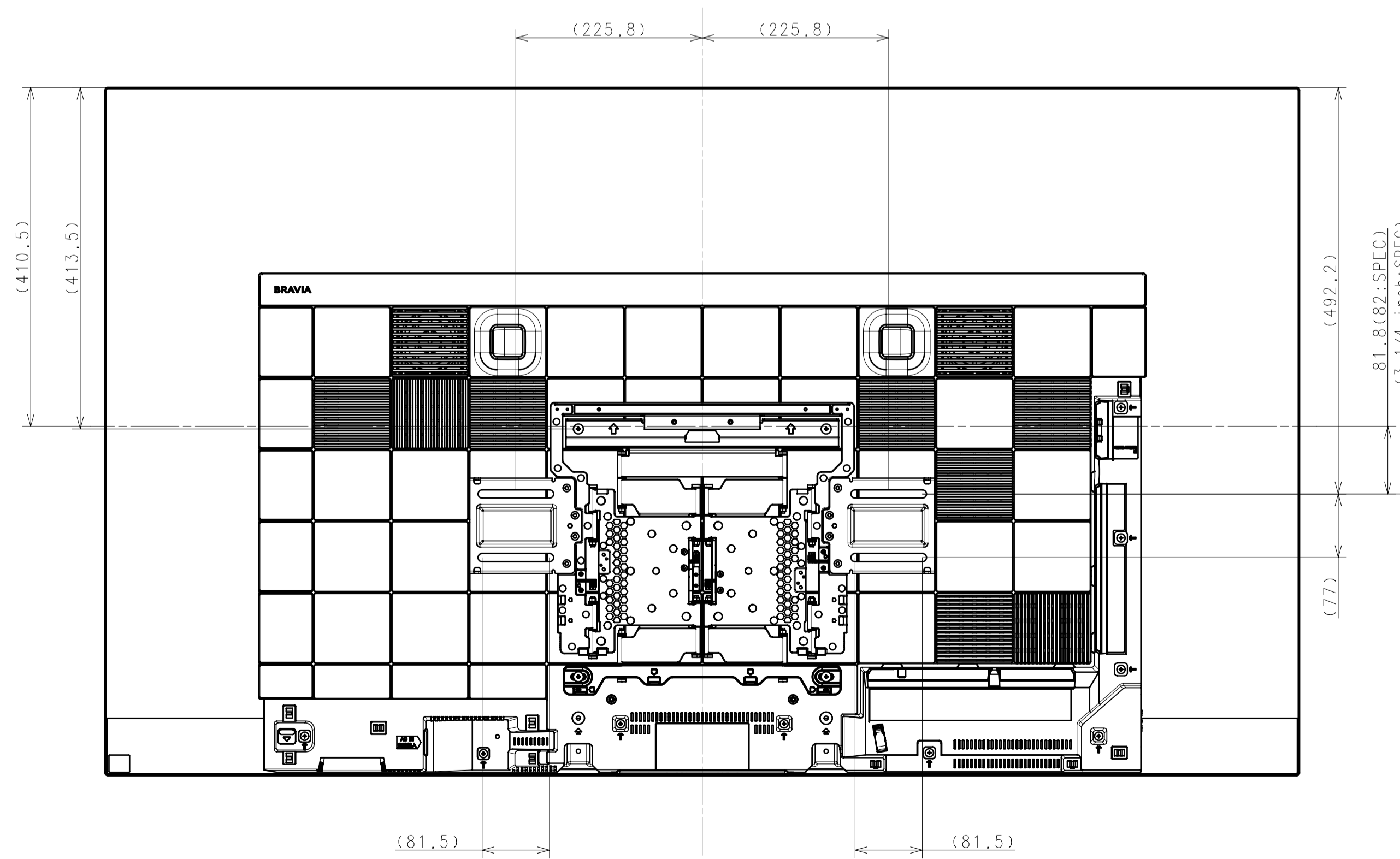
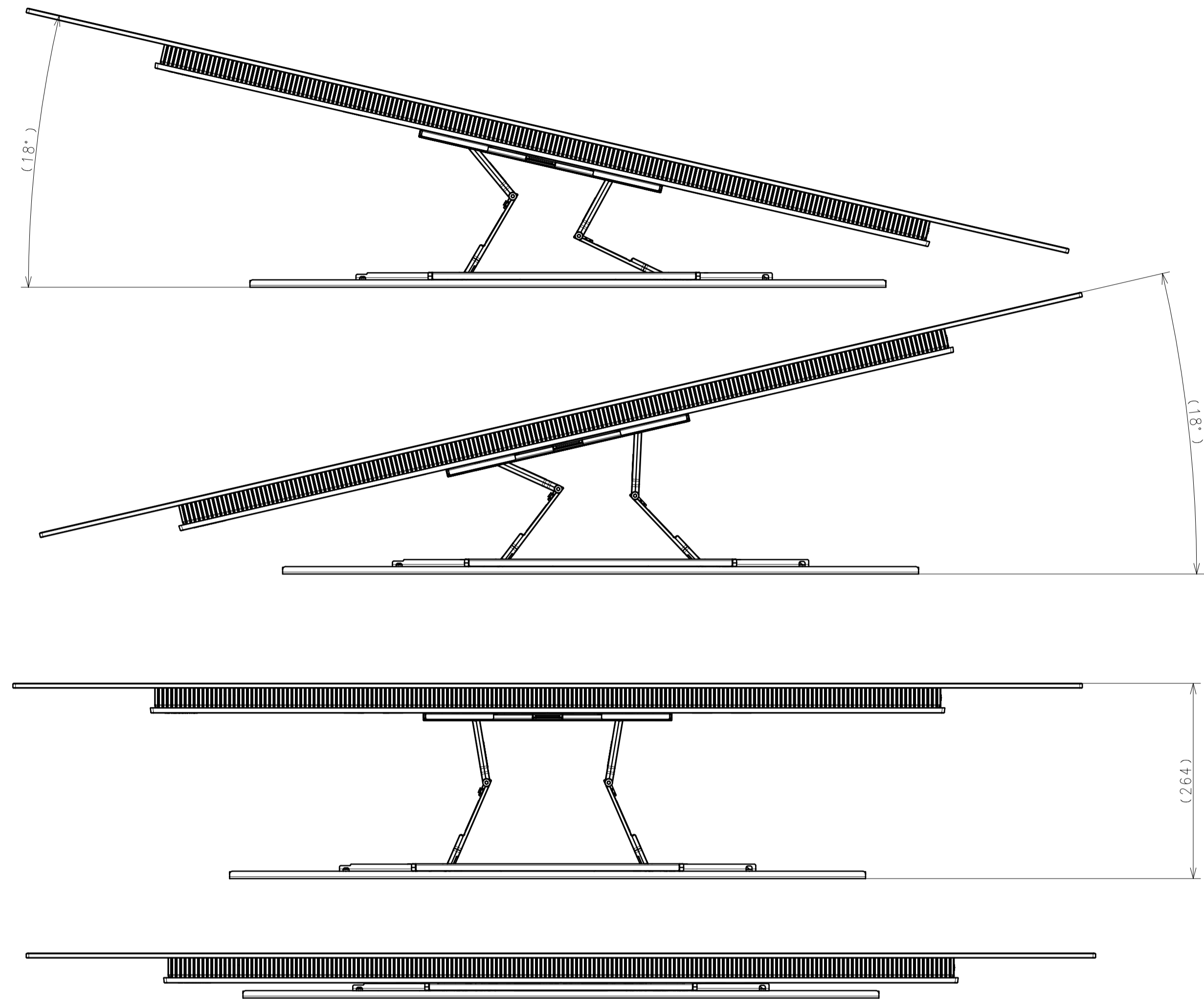
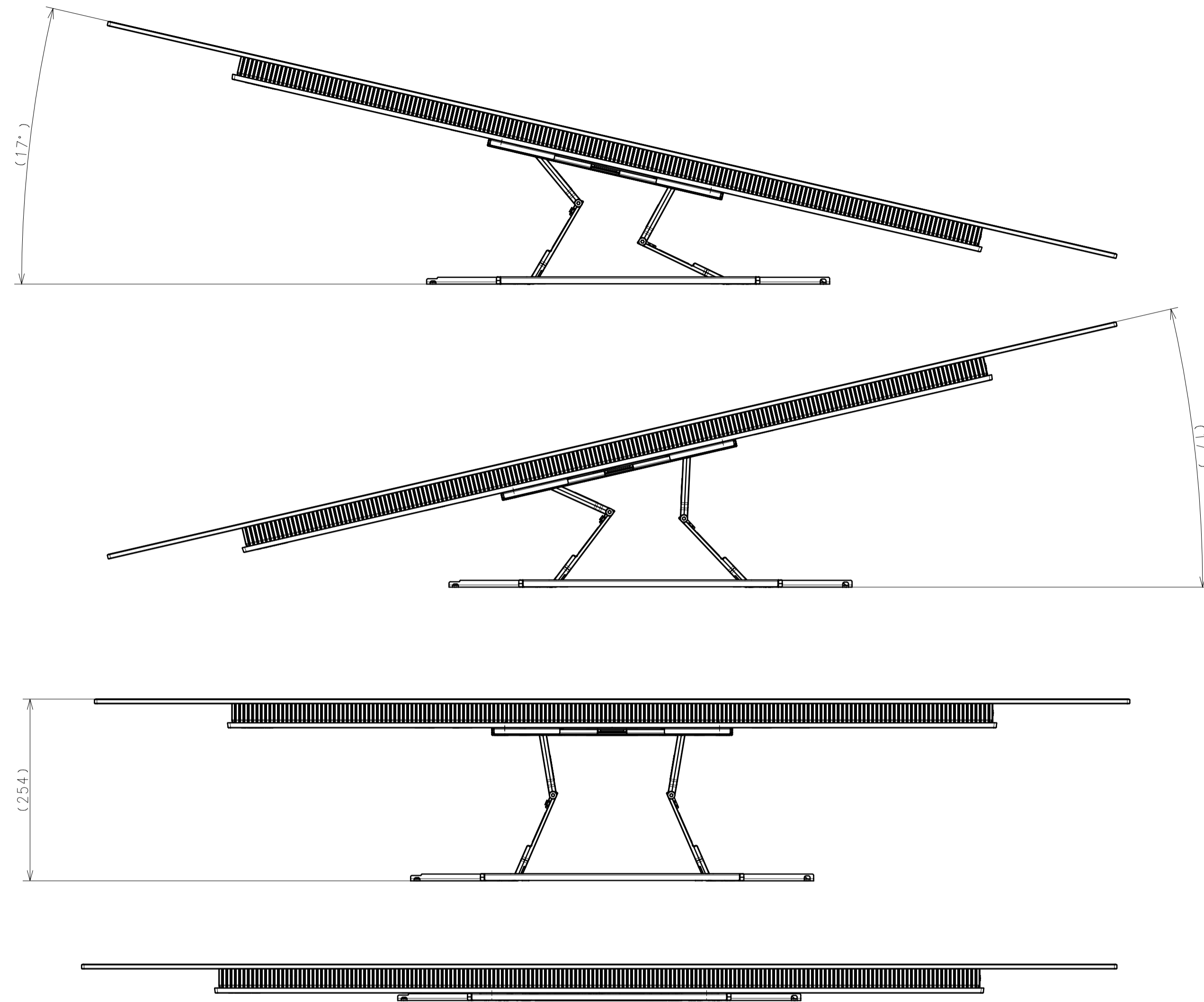

DESCRIPTION 1	65 (A9G) EXTERIOR VIEW	LEGAL OWNER	Sony Corporation	SCALE	1:5
DESCRIPTION 2	65 (A9G) EXTERIOR VIEW	PART NO.		SHEET/PAGES	3 / 3