

Area	JAPAN	NORTH AMERICA	LATIN AMERICA	EUROPE	EUROPE DERIVATIVE 1	GENERAL AREA
Model Name	KJ-50X80J	KD-50X80J	KD-50X80J	KD-50X81J	KD-50X82J	KD-50X80J
SV No.	SV-39149	SV-39008	SV-39023	SV-39131	SV-39127	SV-39045
DIMENSION	TV only (W x H x D)	112.6 x 65.3 x 7.0 cm	1126 x 653 x 70 mm / 44 3/8 x 25 3/4 x 2 7/8 inch	1126 x 653 x 70 mm	Approx. 112.6 x 65.3 x 7.0 cm	Approx. 112.6 x 65.3 x 7.0 cm
	TV with Stand (Standard position) (W x H x D)	112.6 x 71.8 x 28.6 cm	1126 x 718 x 286 mm / 44 3/8 x 28 3/8 x 11 3/8 inch	1126 x 718 x 286 mm	Approx. 112.6 x 71.8 x 28.6 cm	Approx. 112.6 x 71.9 x 30.0 cm
	TV with Stand (Narrow position) (W x H x D)	-	-	-	-	-
	TV with Stand (Soundbar position) (W x H x D)	-	-	-	-	-
	TV with Floor Stand (W x H x D)	-	-	-	-	-
	Stand Width (Standard position)	66.5 cm	665 mm / 26 1/4 inch	665 mm	Approx. 66.5 cm	Approx. 63.1 cm
	Stand Width (Narrow position)	-	-	-	-	-
	Stand Width (Soundbar position)	-	-	-	-	-
	Floor Stand Width	-	-	-	-	-
	VESA Hole Pitch	20.0 x 20.0 cm	200 x 200 mm / 7 7/8 x 7 7/8 inch	200 x 200 mm	20.0 x 20.0 cm	20.0 x 20.0 cm
WEIGHT	TV Only	12.3 kg	12.3 kg / 27.1 lb	12.3 kg	Approx. 12.3 kg	Approx. 12.3 kg
	TV with Stand (Standard position)	12.9 kg	12.9 kg / 28.5 lb	12.9 kg	Approx. 12.9 kg	Approx. 15.9 kg
	TV with Stand (Narrow position)	-	-	-	-	-
	TV with Stand (Soundbar position)	-	-	-	-	-
	TV with Floor Stand	-	-	-	-	-
	Floor Stand weight (Supply)	-	-	-	-	-
	W-M't Br. Weight (Supply)	-	-	-	-	-
Remarks					Center stand	

WITH STAND (EXCEPT KD-50X82J)

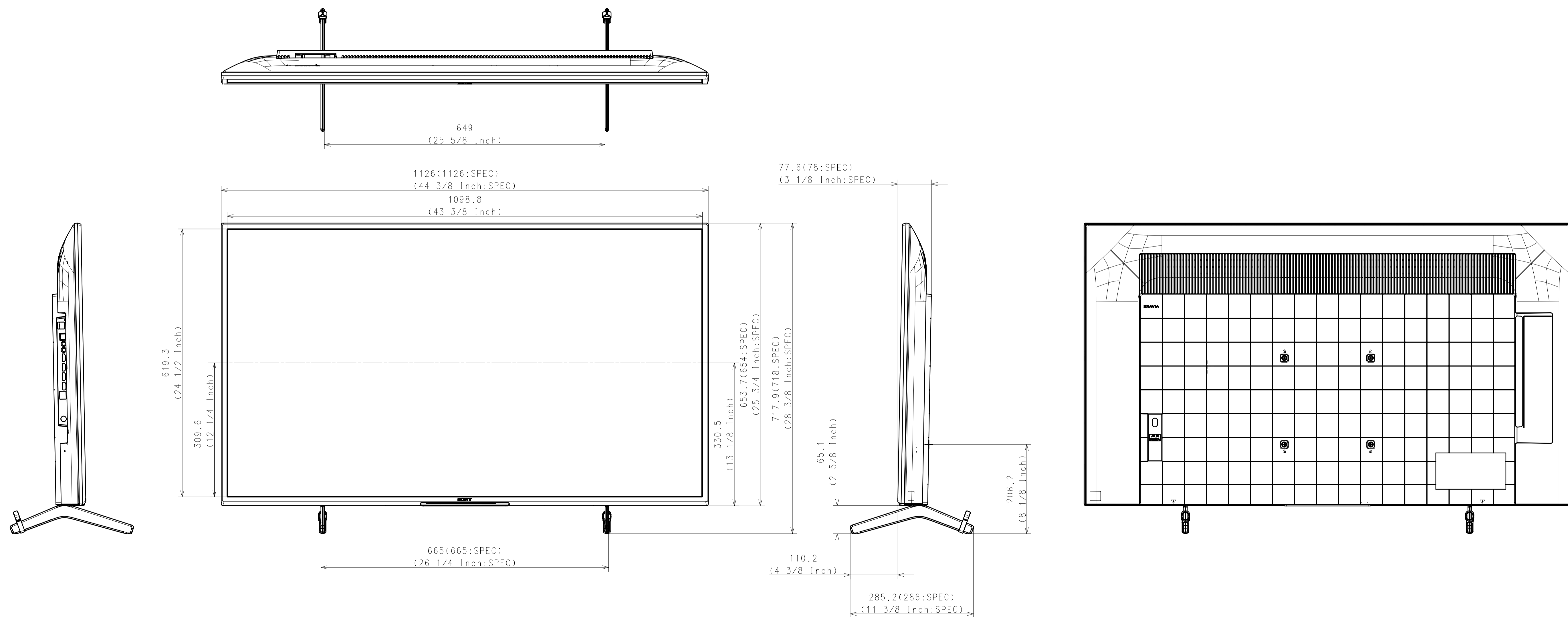

Purchase recycled resins and wire rods only from the business partners that Sony approves as Green Partners.

DATE OF ISSUE	2020.10.01	DOCUMENT TYPE	ASSEMBLY DRAWING
TOLERANCE		FINISH/COLOR	
REVISION	2020.12.03	REVISION	CORRECT INFORMATION
RESPONSIBLE DEPARTMENT	PANEL & MECHANICAL DESIGN	ORIGINAL MODEL	50 (X80J) EXTERIOR VIEW
PLANNED BY	ADLEE	TENTATIVE MODEL	50 (X80J) EXTERIOR VIEW
DRAWN BY	ADLEE	SCALE	1:5
DATE	2020.10.01	SIZE	A1
LEGAL OWNER	Sony Corporation	UNIT	mm
		PART NO.	
		SUFFIX	
		REV. NO.	1/4

WITH STAND (KD-50X82J)

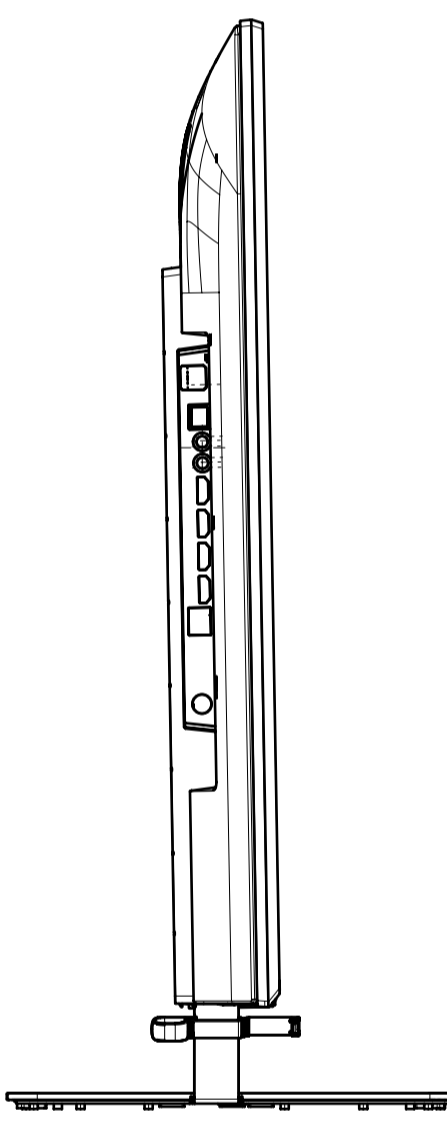
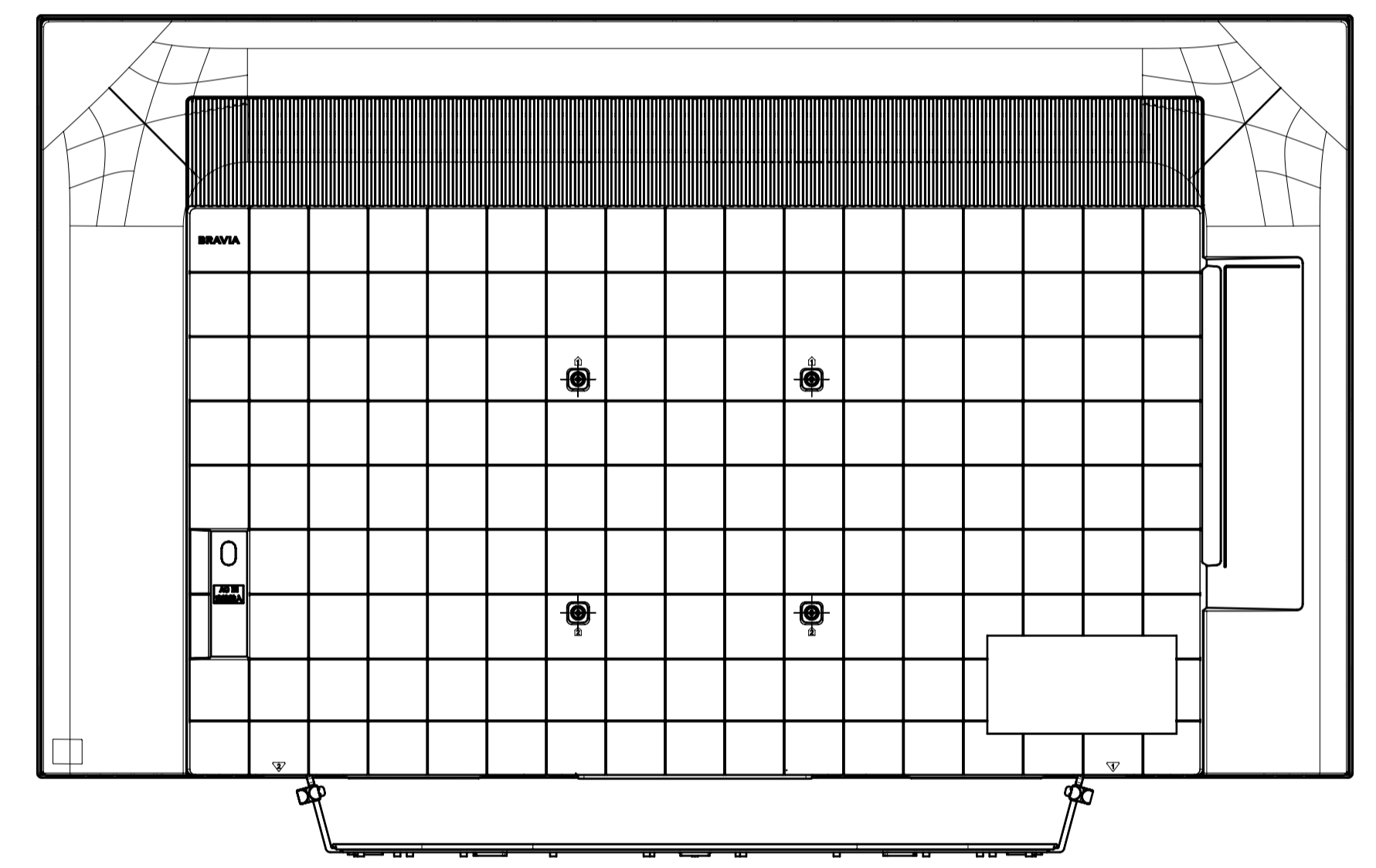
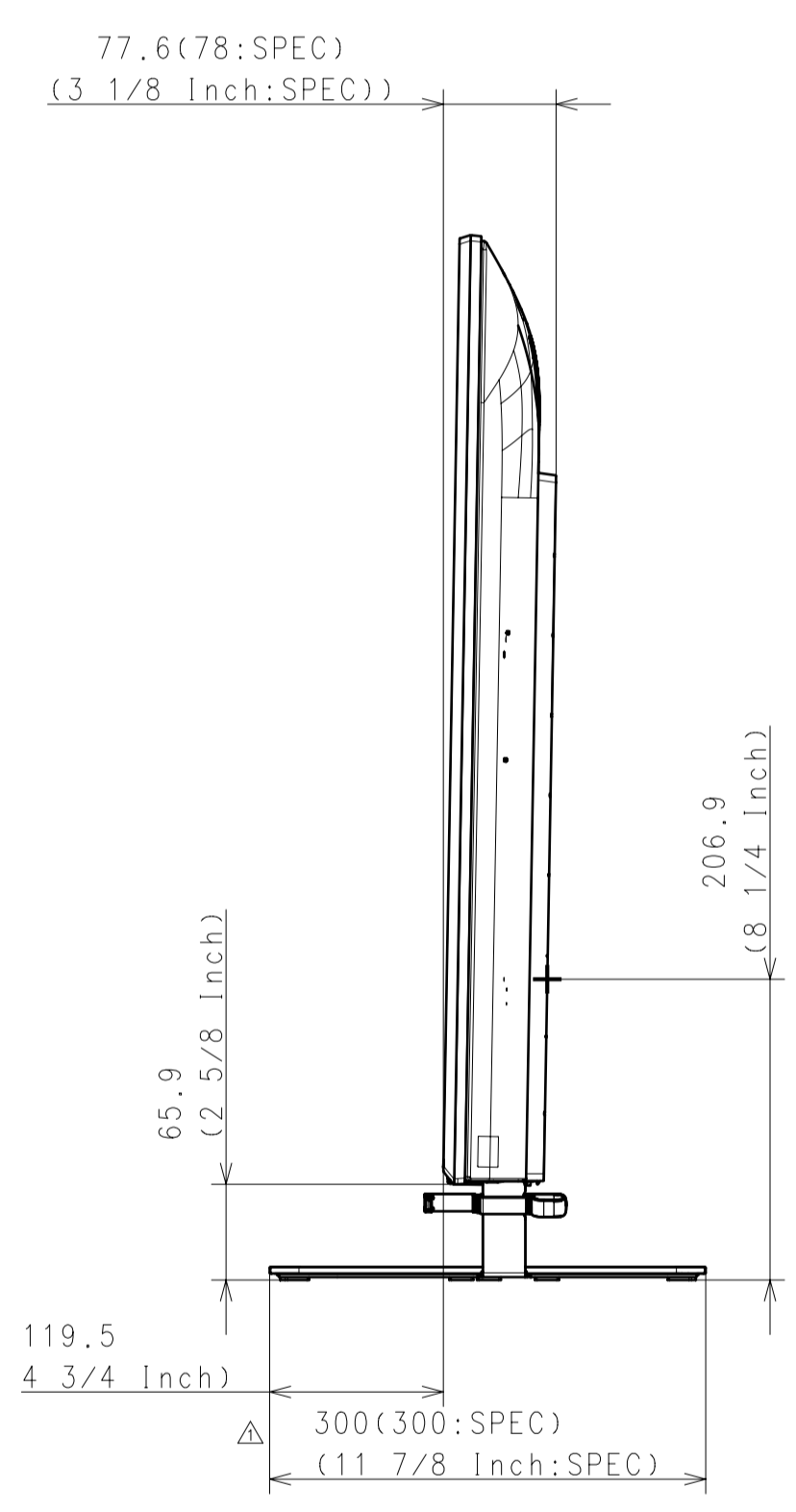
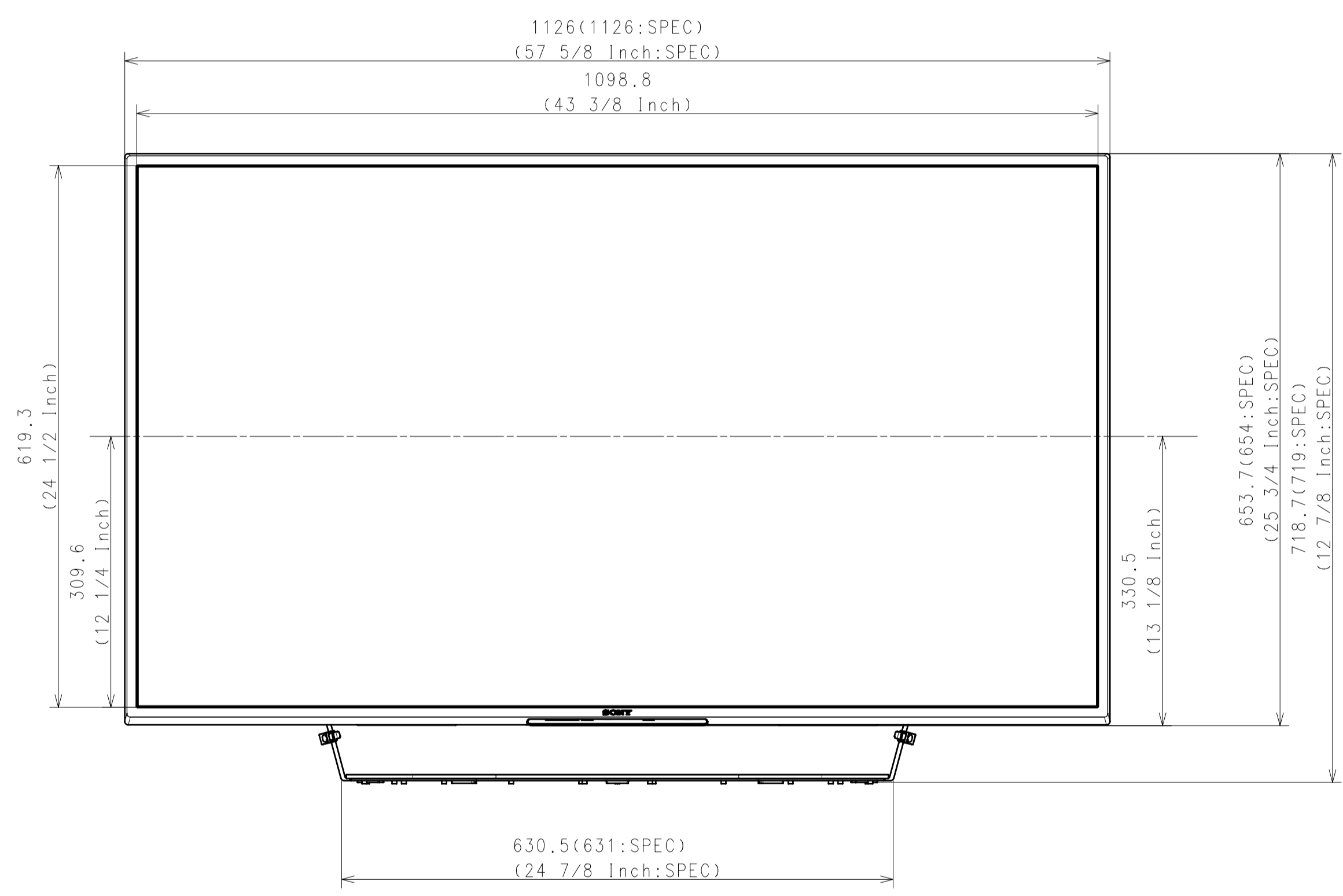
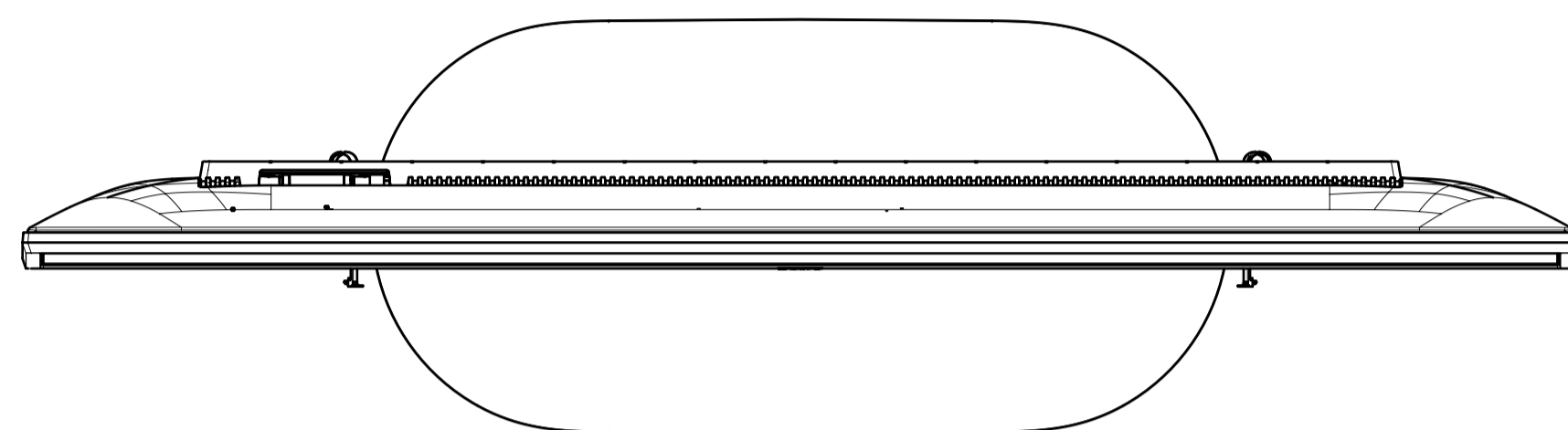

DESCRIPTION 1	LEGAL OWNER	SCALE
50 (X80J) EXTERIOR VIEW	Sony Corporation	1:1
DESCRIPTION 2	PART NO.	SHEET/PAGES
50 (X80J) EXTERIOR VIEW		2 / 4

WITHOUT STAND

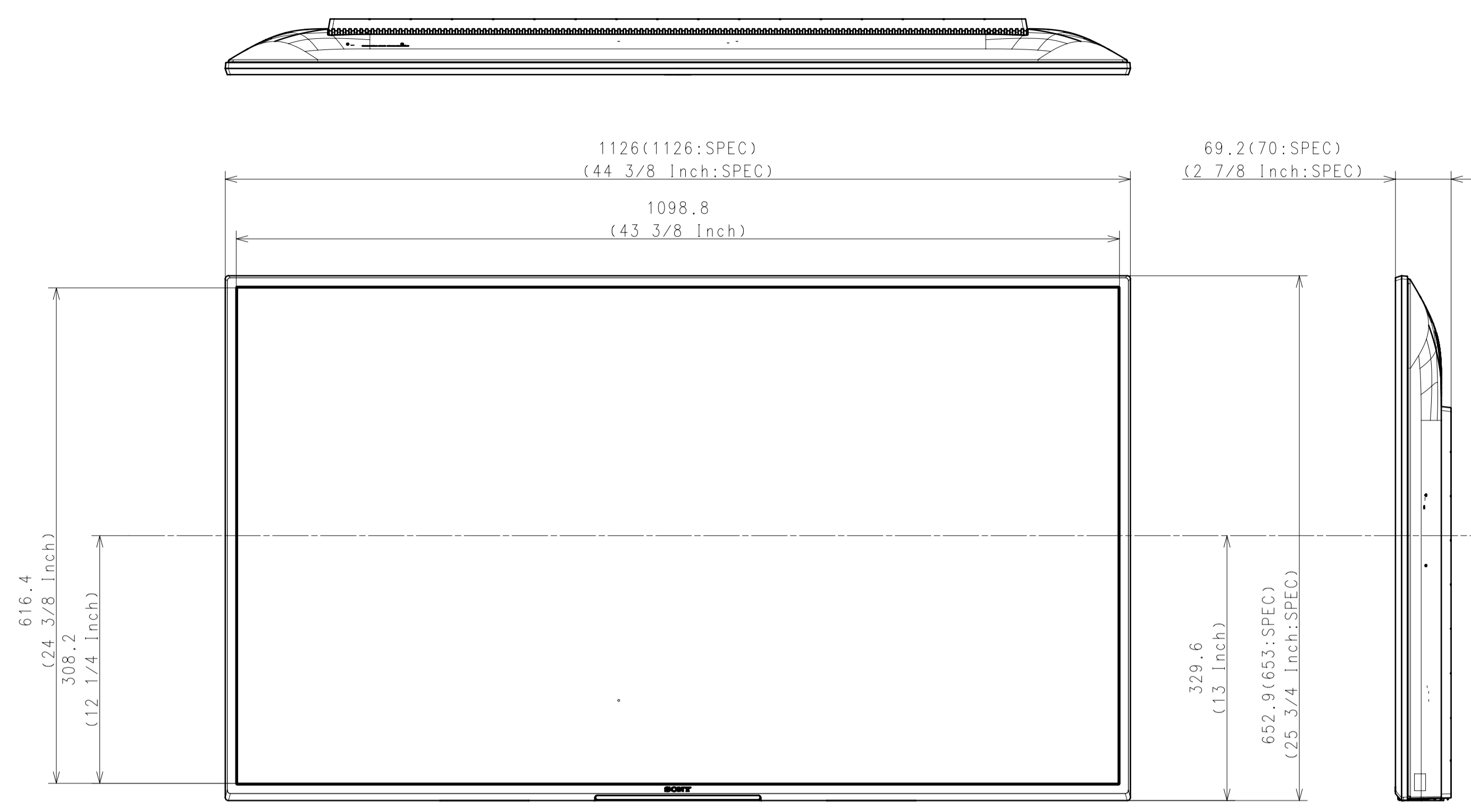

M6 HOLES (WITH VESA SPACER)  
FOR SECURING HARDWARE (ROPE OR CHAIN)

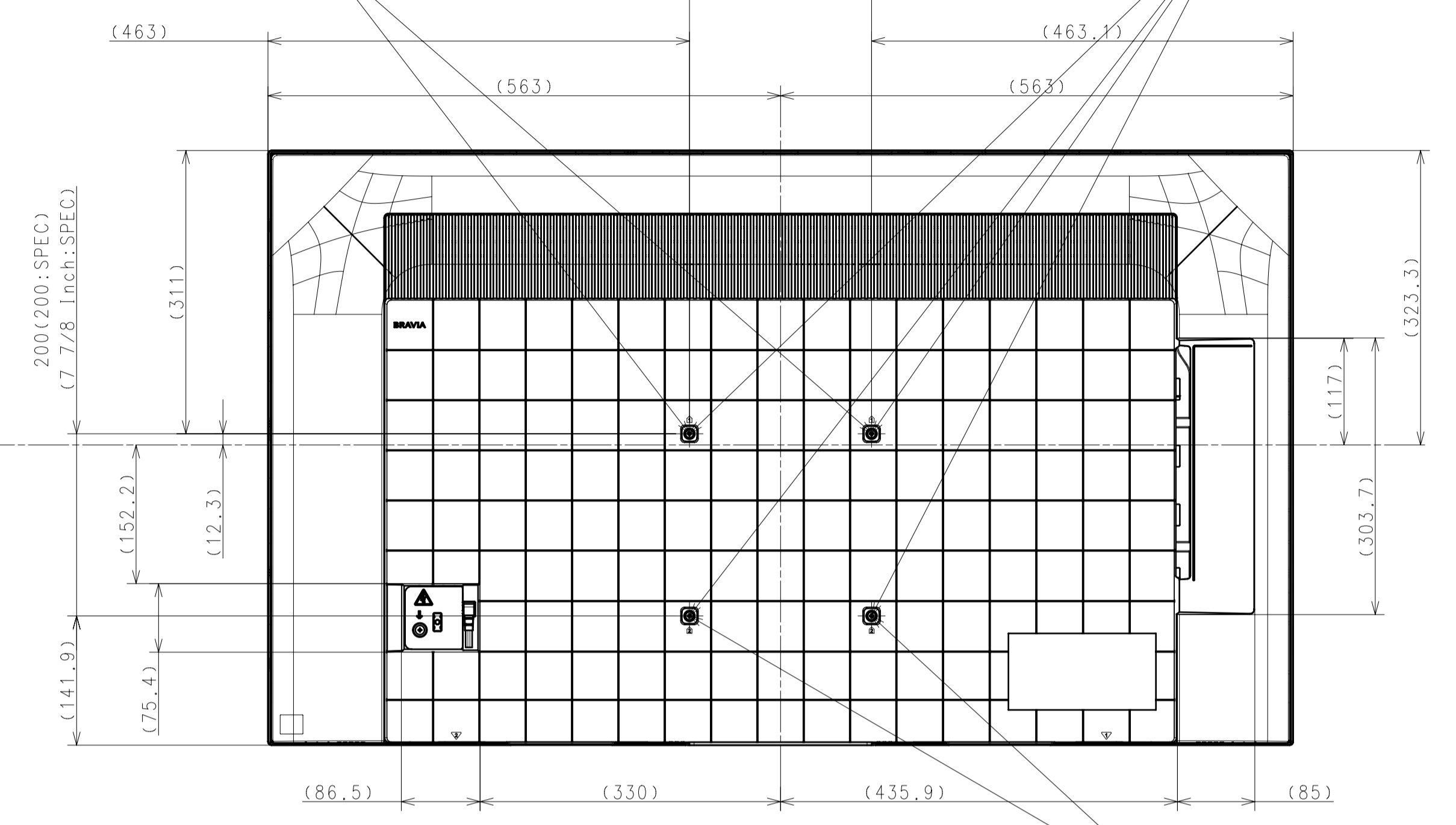

M6 HOLES (WITH VESA SPACER) WALL MOUNT  
\*REFER TO INSTRUCTION MANUAL  
FOR SCREW LENGTH INFORMATION

FOR. CHINA

M6 HOLES (WITH VESA SPACER)  
FOR SECURING HARDWARE (BELT)

SONY STANDARD

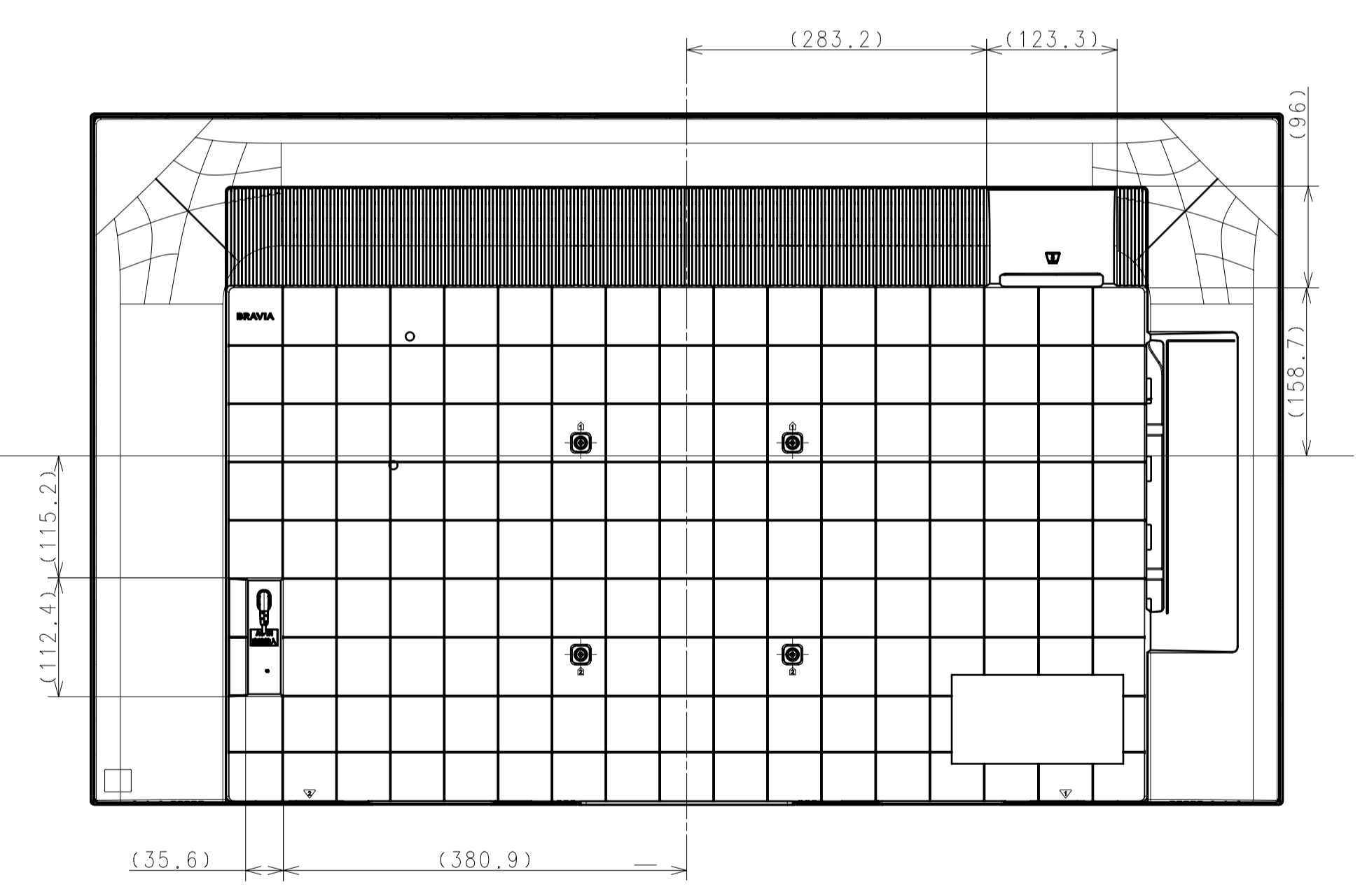

FOR. EUROPE

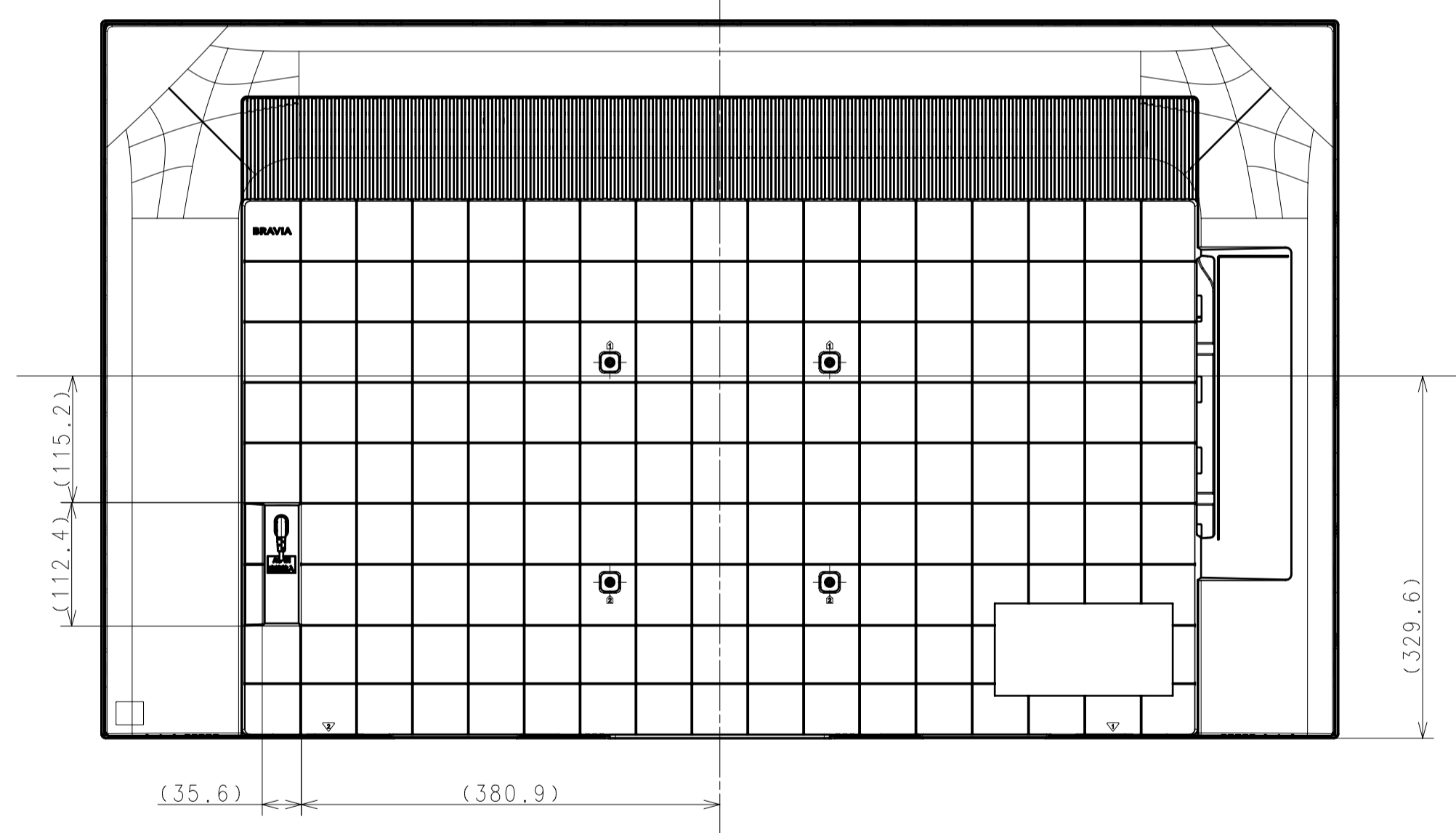

FOR. GENERAL AREA

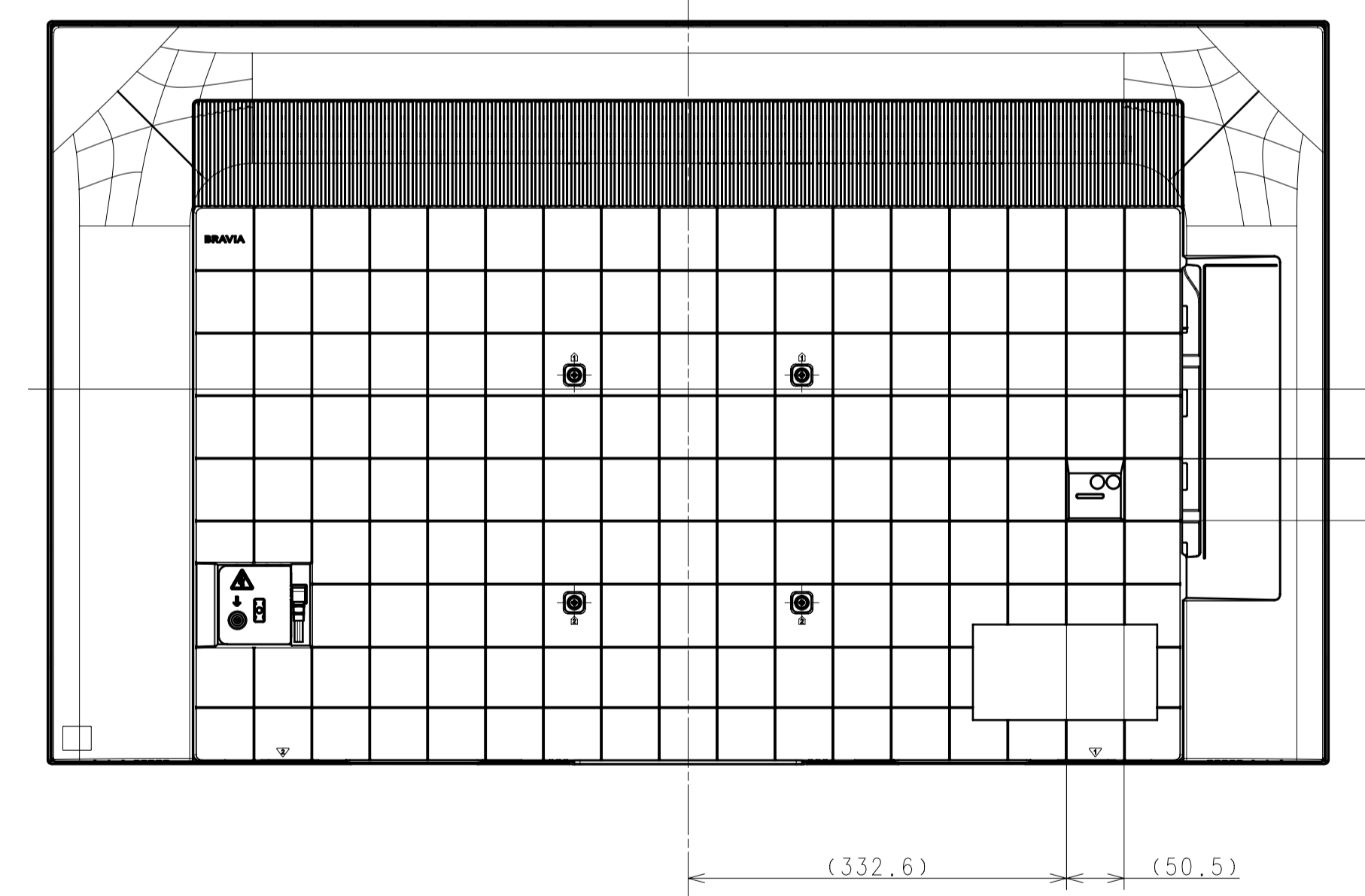

FOR. JAPAN

DESCRIPTION/1	LEGAL OWNER	SCALE
50 (X80J) EXTERIOR VIEW	Sony Corporation	1:1
DESCRIPTION/2	PART NO.	SHEET/PAGES
50 (X80J) EXTERIOR VIEW		3 / 4

SU-WL450

STANDARD

SLIM

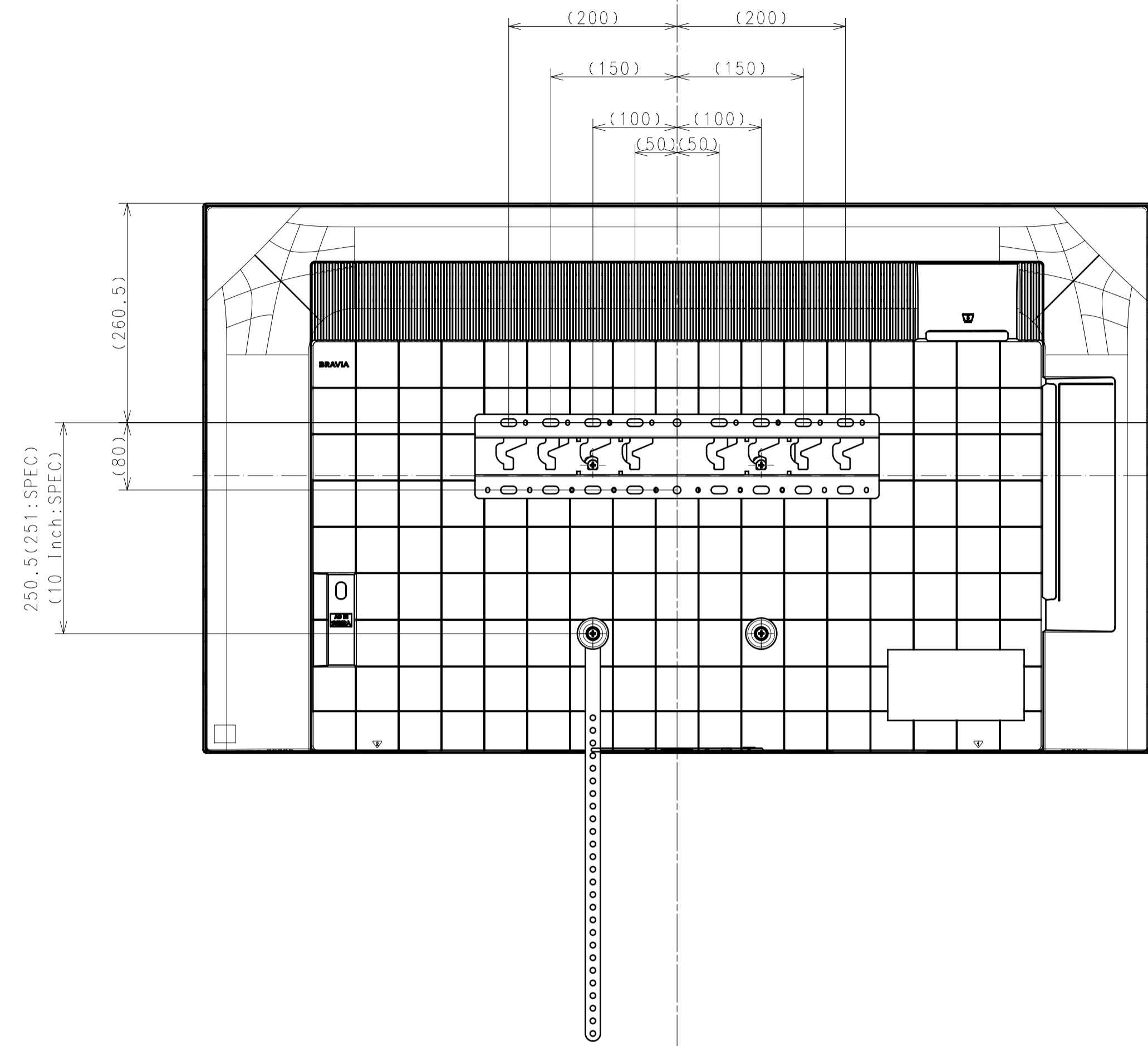

62.8(63:SPEC)  
(2 1/2 INCH:SPEC)

392.4(393:SPEC)  
(15 1/2 INCH:SPEC)

130.8(131:SPEC)  
(5 1/4 Inch:SPEC)

392.4(393:SPEC)  
(15 1/2 INCH:SPEC)

89(89:SPEC)  
(3 5/8 Inch:SPEC)

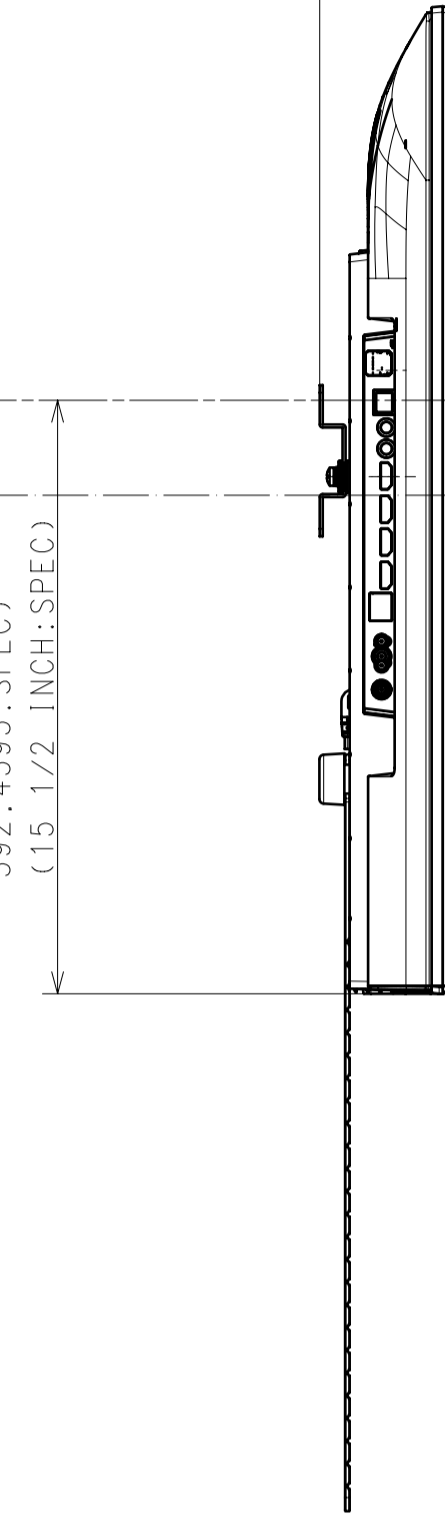
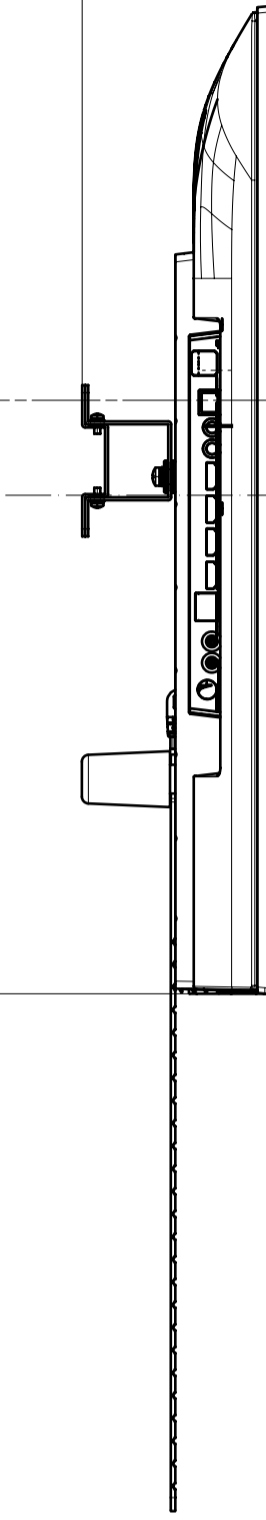

DRAWING

SONY STANDARD

A1

DESCRIPTION	LEGAL OWNER	SCALE
50 (X80J) EXTERIOR VIEW	Sony Corporation	1:1
DESCRIPTION	PART NO.	SHEET/PAGES
50 (X80J) EXTERIOR VIEW		4 / 4