

Area		NORTH AMERICA	EUROPE	GENERAL AREA	CHINA
Model Name		KD-85X85J	KD-85X85J	KD-85X86J	KD-85X85J
SV No.		SV-39183	SV-39351	SV-39233	SV-39308
DIMENSION	TV only (W x H x D)	1899 x 1089 x 71 mm / 74 7/8 x 42 7/8 x 2 7/8 inch	Approx. 189.9 x 108.9 x 7.1 cm	Approx. 1899 x 1089 x 71 mm	Approx. 1899 x 1089 x 71 mm
	TV with Stand (Standard position) (W x H x D)	1899 x 1176 x 456 mm / 74 7/8 x 46 3/8 x 18 inch	Approx. 189.9 x 117.6 x 45.6 cm	Approx. 1899 x 1176 x 456 mm	Approx. 1899 x 1176 x 456 mm
	TV with Stand (Narrow position) (W x H x D)	-	Approx. 189.9 x 117.6 x 45.6 cm	-	-
	TV with Stand (Soundbar position) (W x H x D)	-	-	-	-
	TV with Floor Stand (W x H x D)	-	-	-	-
	Stand Width (Standard position)	1532 mm / 60 3/8 inch	Approx. 153.2 cm	Approx. 1532 mm	Approx. 1532 mm
	Stand Width (Narrow position)	-	Approx. 66.0 cm	-	-
	Stand Width (Soundbar position)	-	-	-	-
	Floor Stand Width	-	-	-	-
WEIGHT	VESA Hole Pitch	400 x 400 mm / 15 3/4 x 15 3/4 inch	40.0 x 40.0 cm	400 x 400 mm	400 x 400 mm
	TV Only	44.5 kg / 98.1 lb	Approx. 44.5 kg	Approx. 44.5 kg	Approx. 44.5 kg
	TV with Stand (Standard position)	46 kg / 101.4 lb	Approx. 46 kg	Approx. 46 kg	Approx. 46 kg
	TV with Stand (Narrow position)	-	Approx. 46 kg	-	-
	TV with Stand (Soundbar position)	-	-	-	-
	TV with Floor Stand	-	-	-	-
	Floor Stand weight (Supply)	-	-	-	-
W-M't Br. Weight (Supply)	-	-	-	-	
Remarks			2way		

WITH STAND

STANDARD POSITION
Applicable to all models

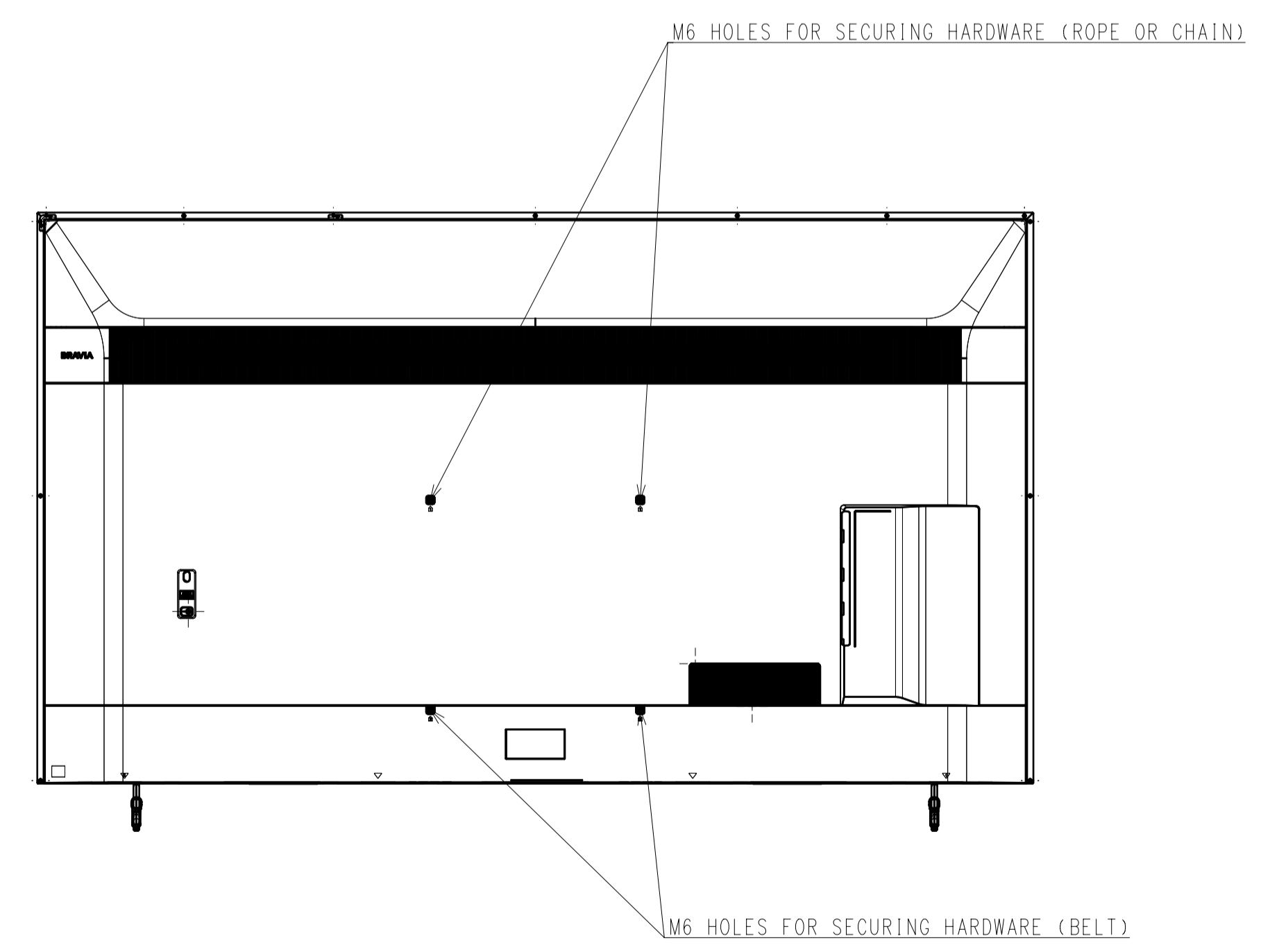
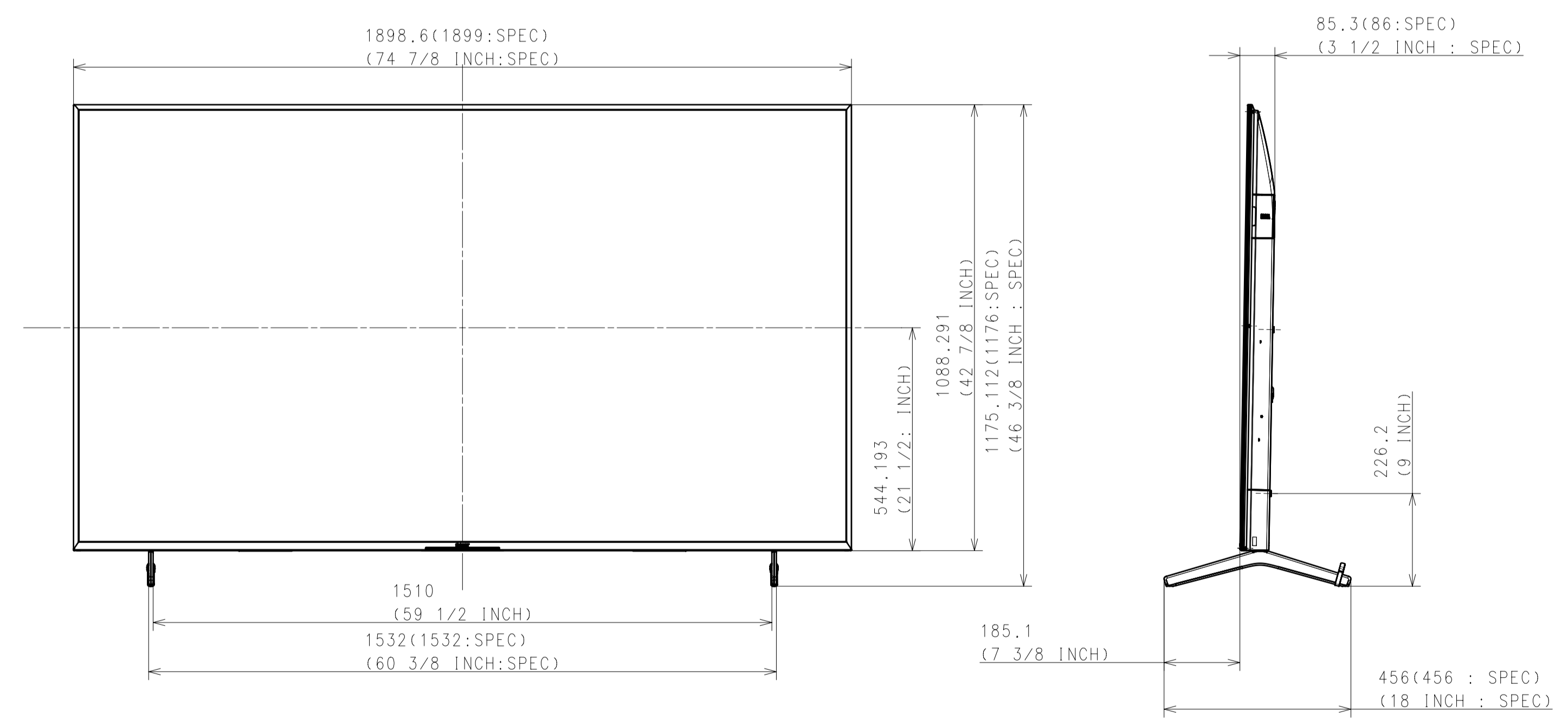
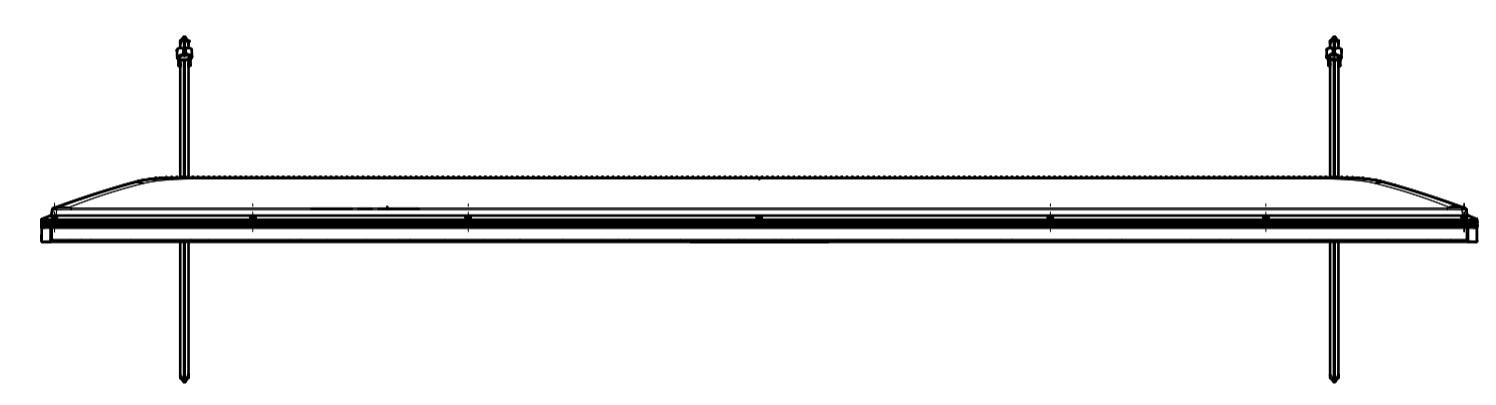

Purchase recycled resins and wire rods only from the business partners that Sony approves as Green Partners.
再生樹脂・電線鋼線はグリーンパートナー 認定製品からの調達を求めます。

DATE OF ISSUE 2020.12.02	DOCUMENT TYPE PART	DATE OF ISSUE 2020.12.02	DOCUMENT TYPE PART
TOLERANCE DRAWING (JIS & ISO/IEC 8015)	TOLERANCE DRAWING (JIS & ISO/IEC 8015)	TOLERANCE DRAWING (JIS & ISO/IEC 8015)	TOLERANCE DRAWING (JIS & ISO/IEC 8015)
MATERIAL COLOR	FINISH COLOR	MATERIAL COLOR	FINISH COLOR
LEGAL OWNER Sony Corporation	RESPONSIBLE DEPARTMENT PANEL & MECHANICAL DESIGN	ORIGINAL MODEL 85 (X 85J) EXTERIOR VIEW	DESCRIPTION 85 (X 85J) EXTERIOR VIEW
PLANNED BY 2020.12.02 TAN DCS-MECH	DESIGNED BY 2020.12.02 TAN DCS-MECH	APPROVED BY 2020.12.02 TAN DCS-MECH	SCALE 1:10
SIZE A1	UNIT mm	PAGE NO. 1 / 4	SHEET/PAGES 1 / 4

WITH STAND

NARROW POSITION
FOR KD-85X85J/ KD-85X85TJ (EUROPE) ONLY

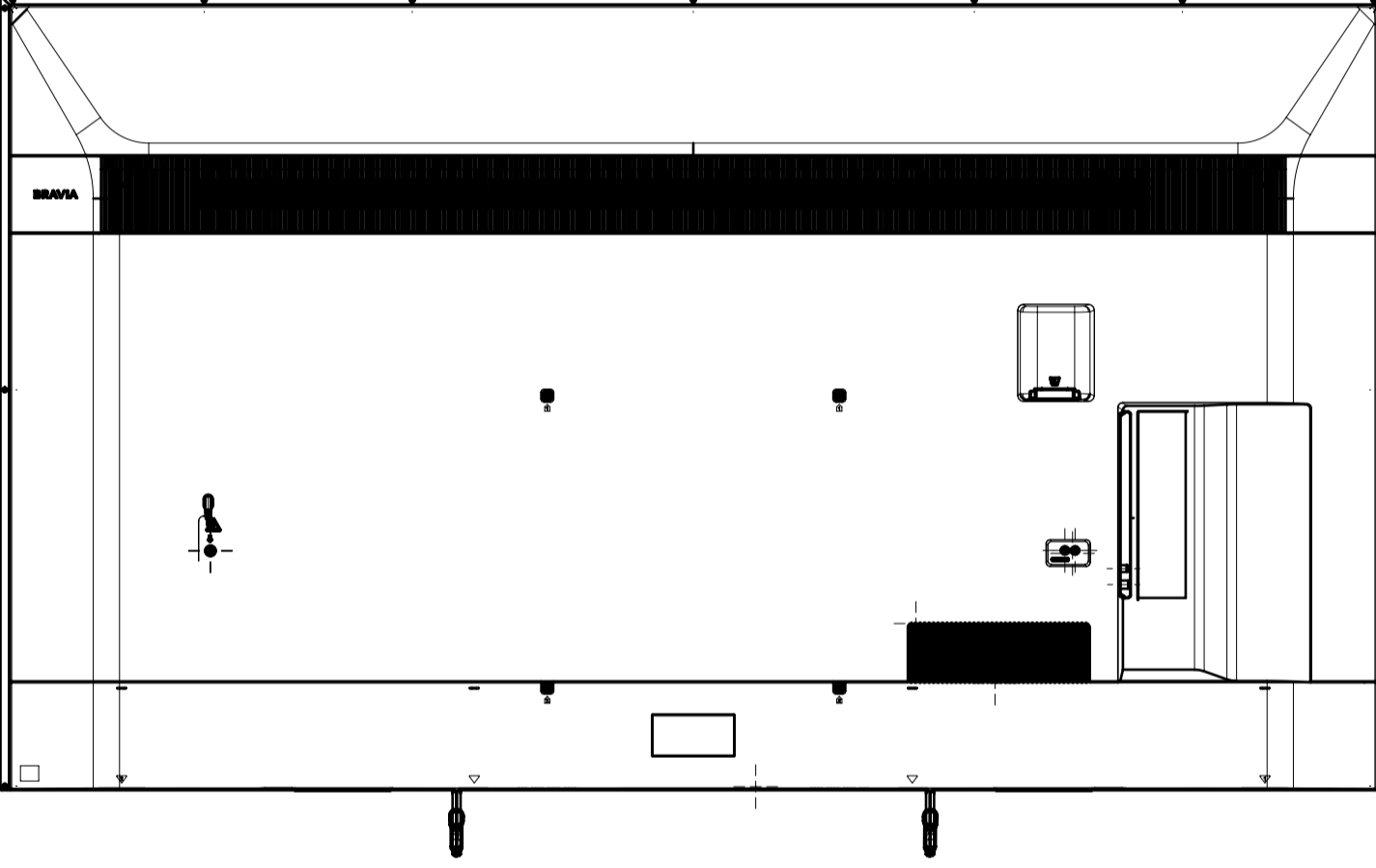
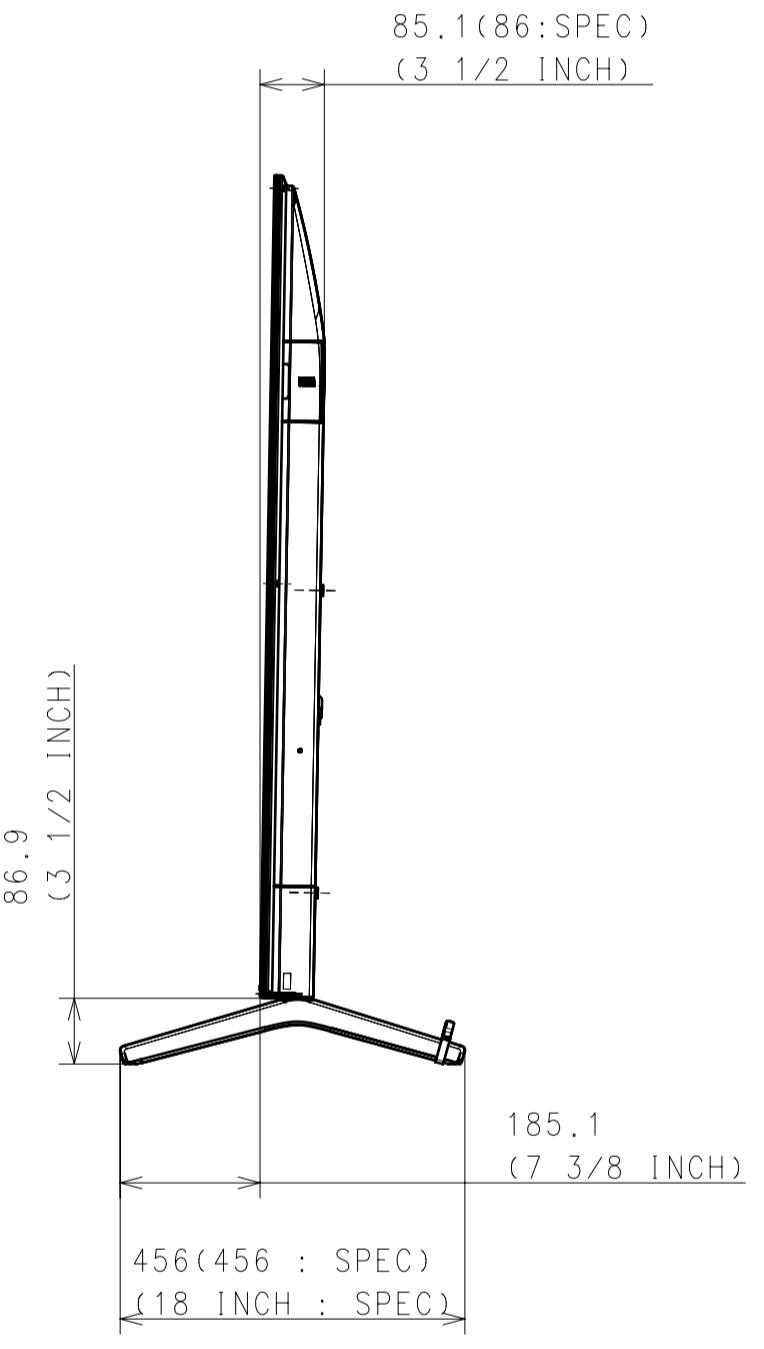
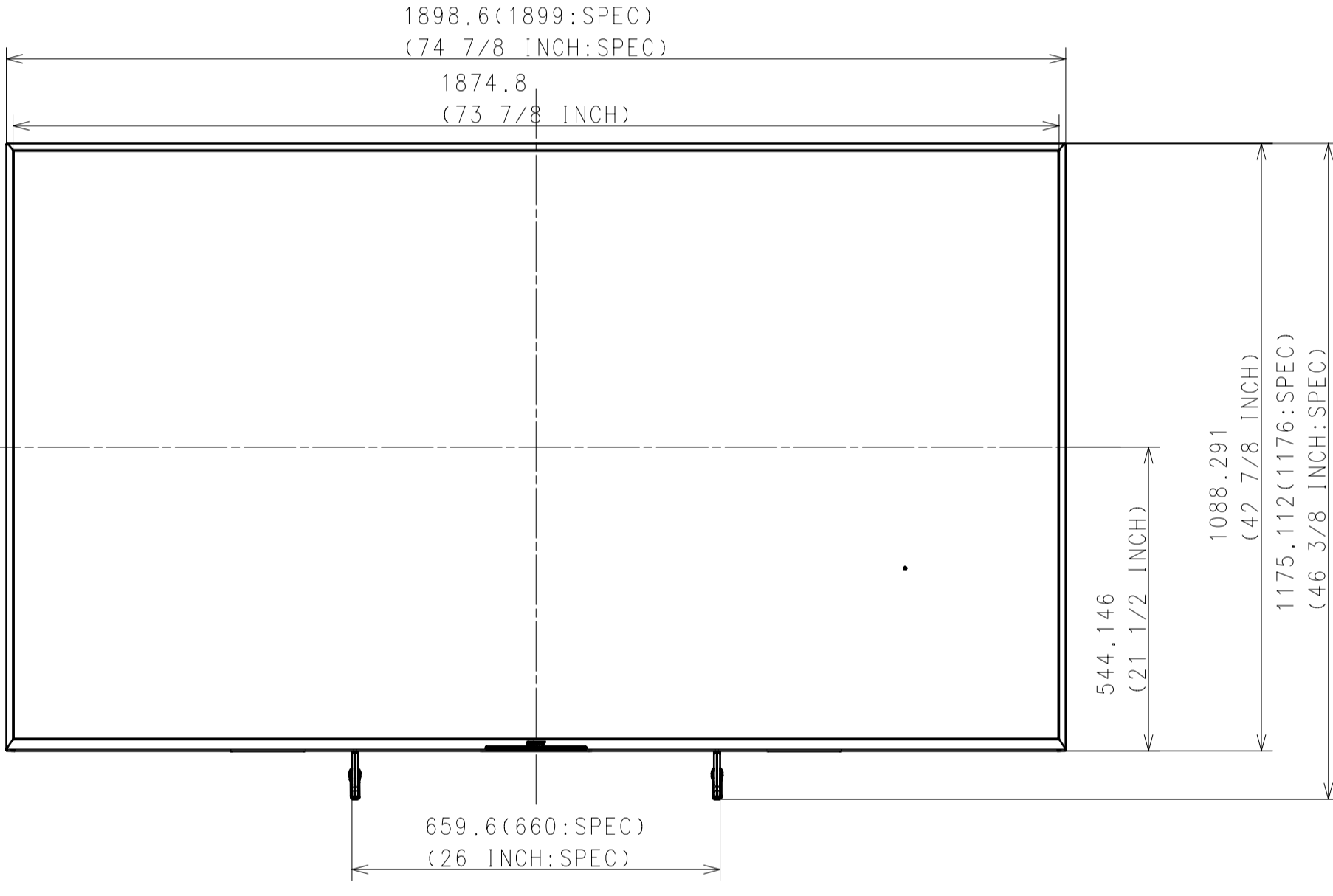
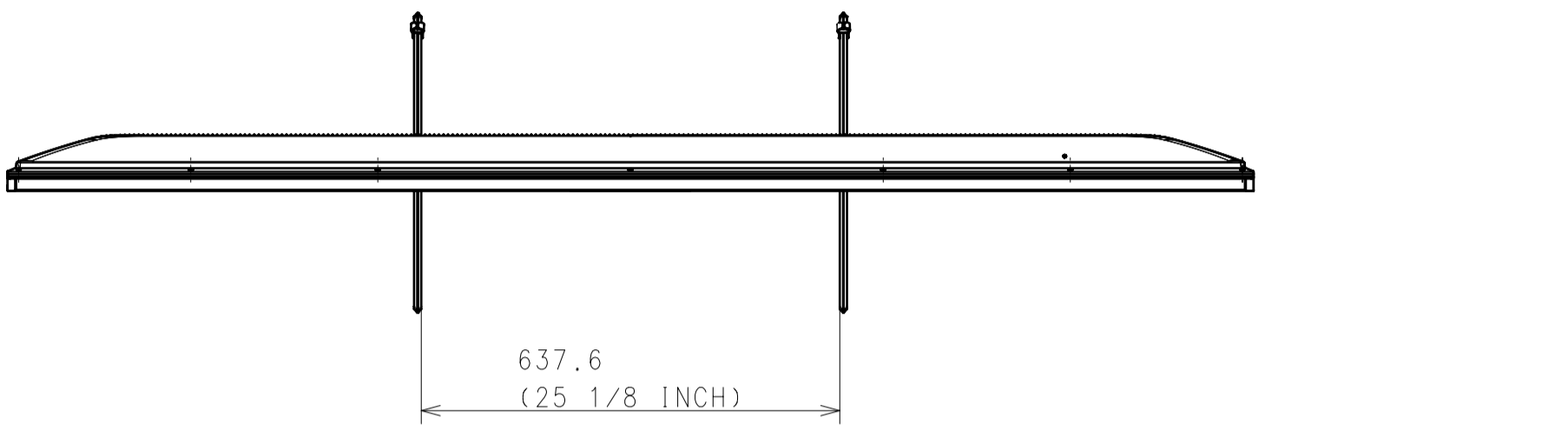

DESCRIPTION	LEGAL OWNER	SCALE
85 (X 85J) EXTERIOR VIEW	Sony Corporation	1:1
DESCRIPTION	PART NO.	SHEET/PAGES
85 (X 85J) EXTERIOR VIEW		4 / 4

WITHOUT STAND

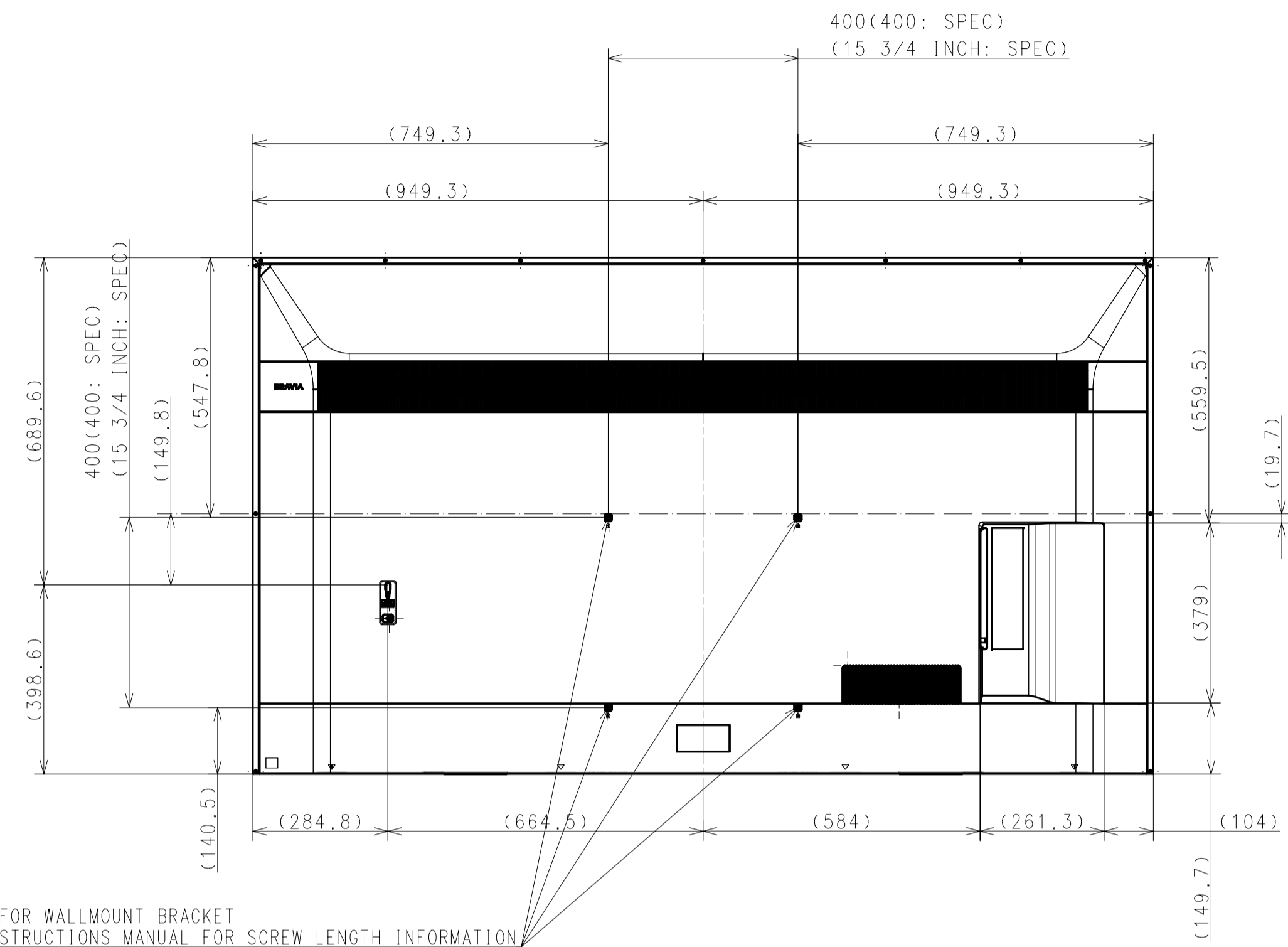
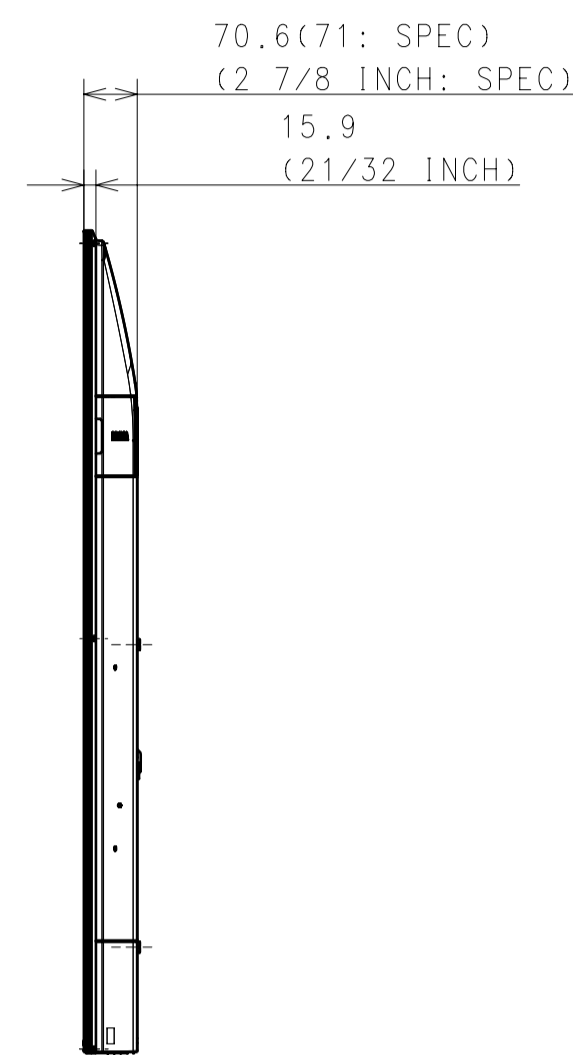
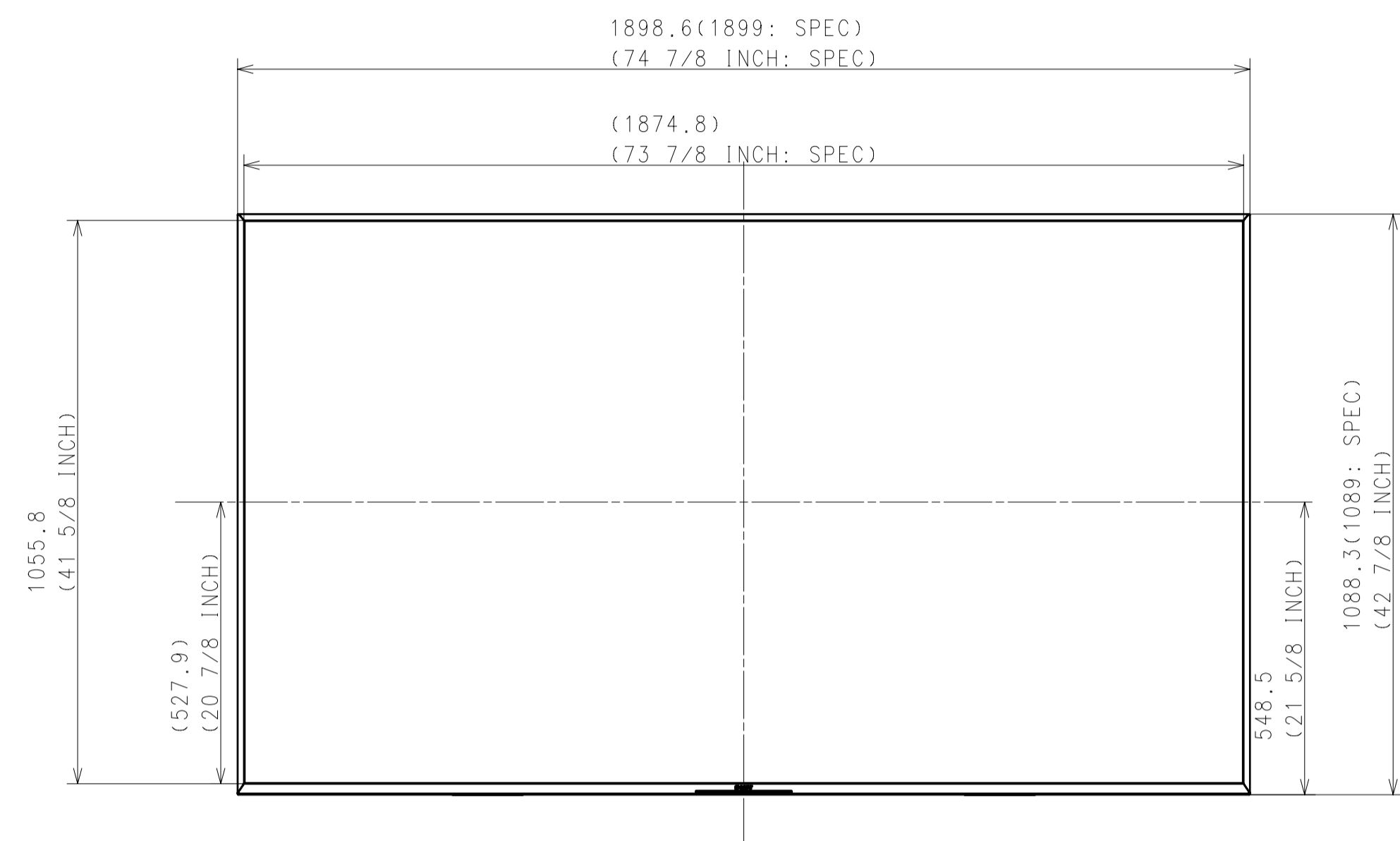

M6 HOLES FOR WALLMOUNT BRACKET
#REFER INSTRUCTIONS MANUAL FOR SCREW LENGTH INFORMATION

For NORTH AMERICA, GENERAL AREA, CHINA

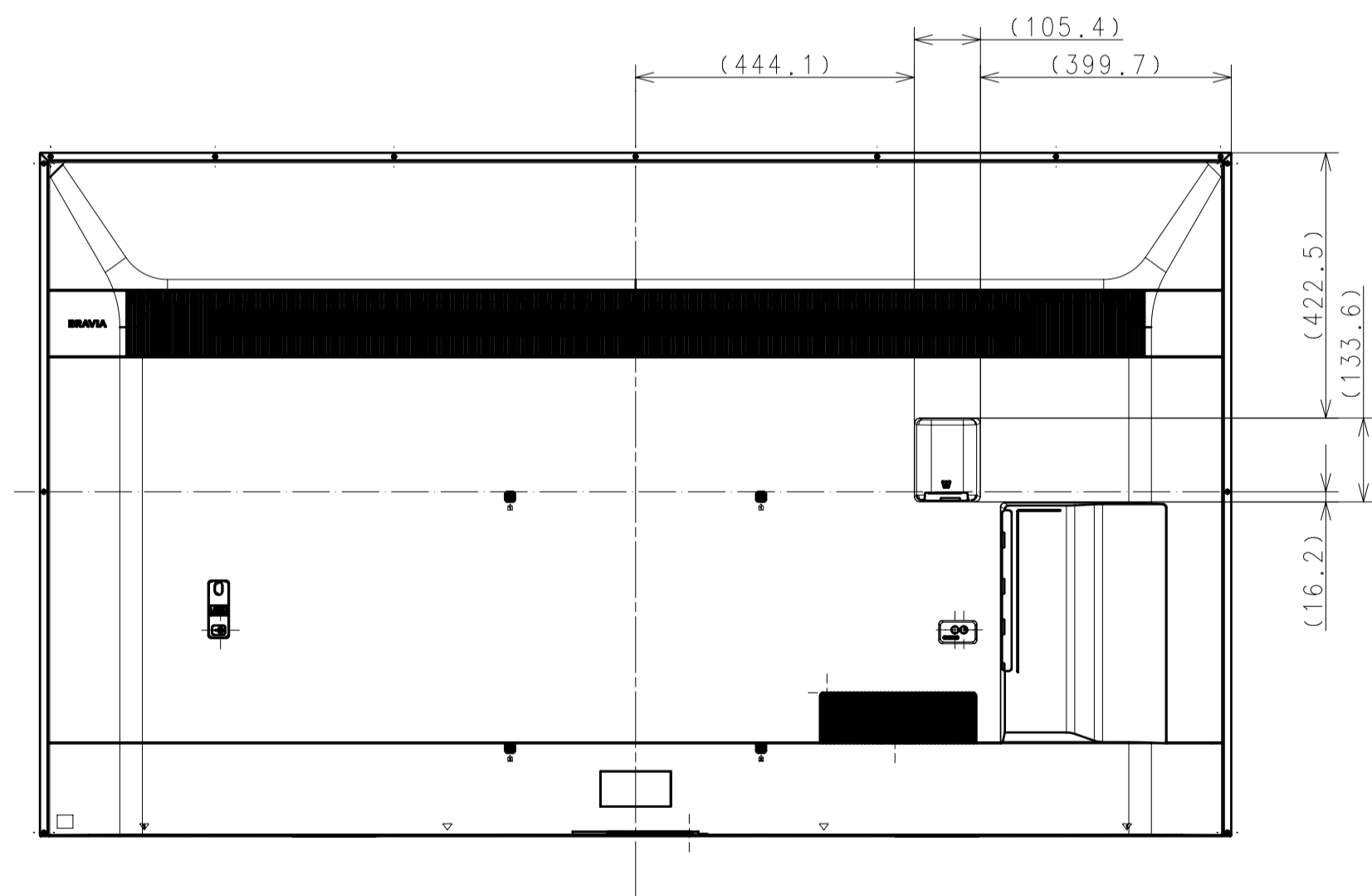
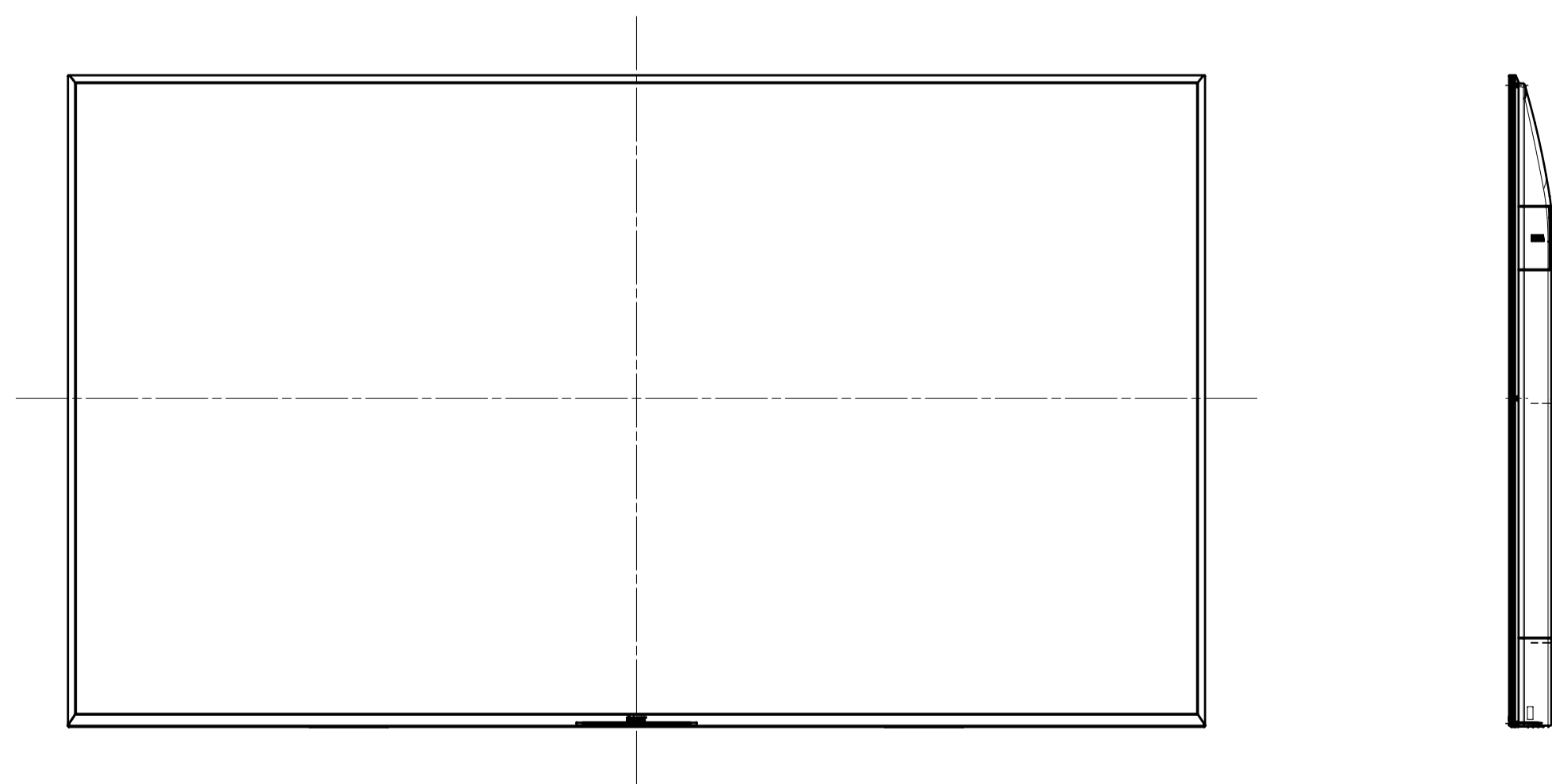

For EUROPE

DESCRIPTION	LEGAL OWNER	SCALE
85 (X 85J) EXTERIOR VIEW	Sony Corporation	1:1
DESCRIPTION	PART NO.	SHEET/PAGES
85 (X 85J) EXTERIOR VIEW		2 / 4

SU_WL450 SLIM

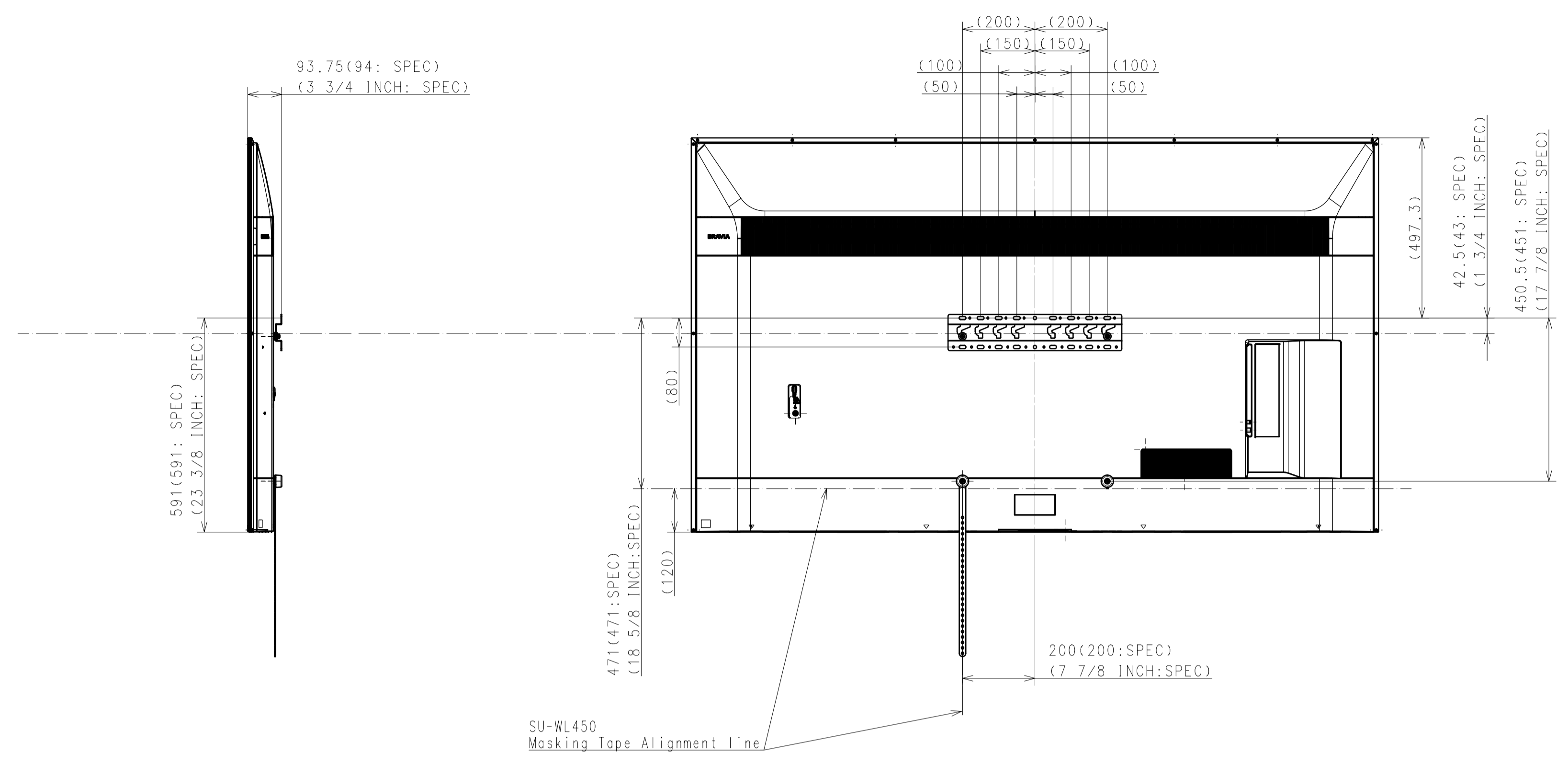

SU_WL450 STANDARD

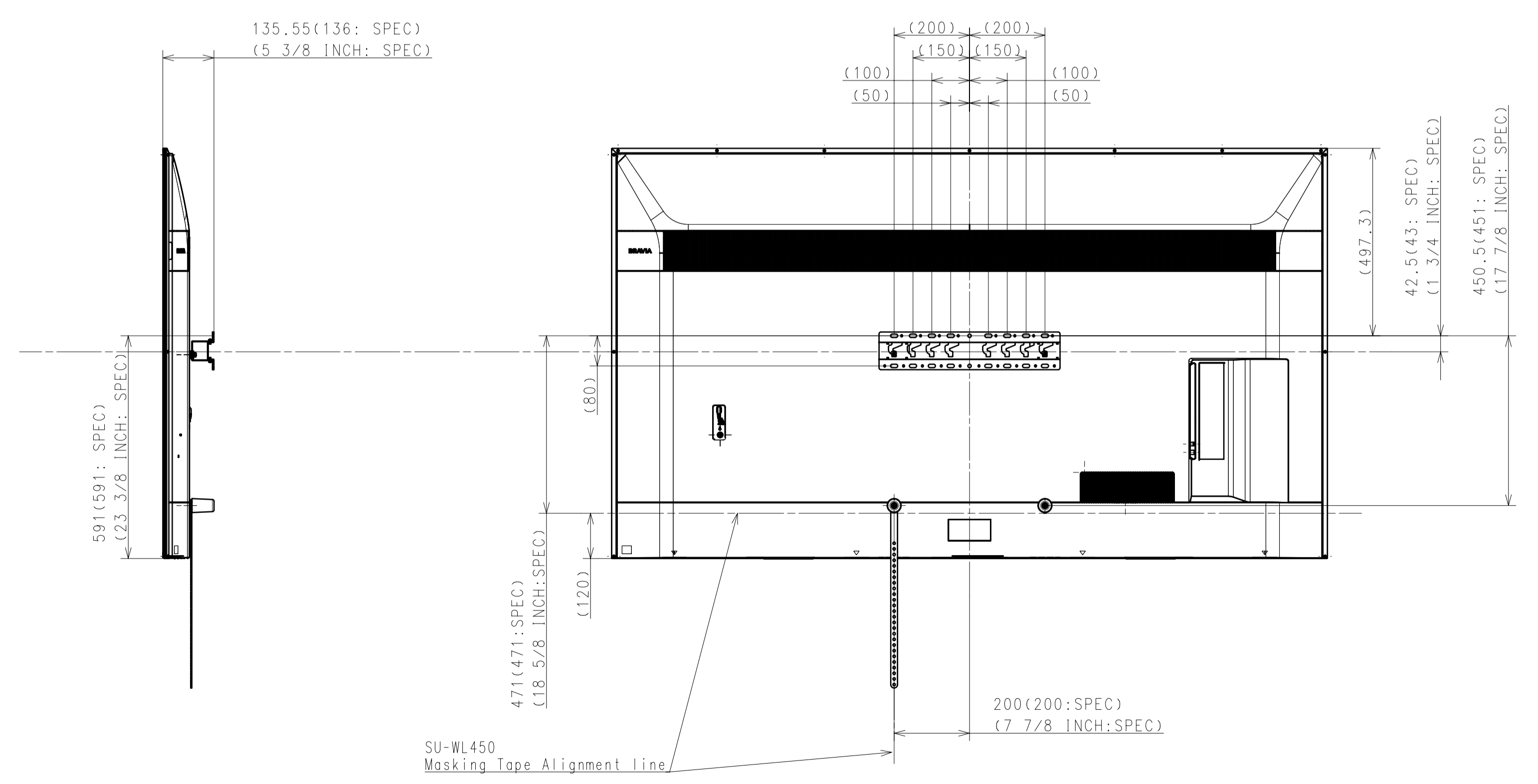

DESCRIPTION 1	LEGAL OWNER	SCALE
85 (X 85J) EXTERIOR VIEW	Sony Corporation	1:1
DESCRIPTION 2	PART NO.	SHEET/PAGES
85 (X 85J) EXTERIOR VIEW		3 / 4