

Area		NORTH AMERICA	LATIN AMERICA	EUROPE	GENERAL AREA	CHINA
Model Name		KD-75X85K	KD-75X85K	KD-75X85K	KD-75X85K	KD-75X85K
SV No.		SV-40217	SV-40236	SV-40331	SV-40268	SV-40301
DIMENSION	TV only (W x H x D)	1675 x 962 x 73 mm / 66 x 37 7/8 x 2 7/8 inch	1675 x 962 x 73 mm	Approx. 167.5 x 96.2 x 7.3 cm	Approx. 1675 x 962 x 73 mm	Approx. 1675 x 962 x 73 mm
	TV only with camera (WxHxD)	-	-	-	-	-
	TV with Stand (Standard position) (W x H x D)	1675 x 1040 x 410 mm / 66 x 41 x 16 1/4 inch	1675 x 1040 x 410 mm	Approx. 167.5 x 104.1 x 41.2 cm	Approx. 1675 x 1041 x 412 mm	Approx. 1675 x 1041 x 412 mm
	TV with Stand (Narrow position) (W x H x D)	-	-	Approx. 167.5 x 104.1 x 41.2 cm	-	-
	TV with Stand (Soundbar position) (W x H x D)	-	-	-	-	-
	TV with Stand (Front position style) (W x H x D)	-	-	-	-	-
	TV with Stand (Back position style) (W x H x D)	-	-	-	-	-
	TV with Floor Stand (W x H x D)	-	-	-	-	-
	Stand Width (Standard position)	1330 mm / 52 3/8 inch	1330 mm	Approx. 132.9 cm	Approx. 1329 mm	Approx. 1329 mm
	Stand Width (Narrow position)	-	-	Approx. 55.9 cm	-	-
	Stand Width (Soundbar position)	-	-	-	-	-
	Stand Width (Front position style)	-	-	-	-	-
	Stand Width (Back position style)	-	-	-	-	-
	Floor Stand Width	-	-	-	-	-
VESA Hole Pitch	300 x 300 mm / 11 7/8 x 11 7/8 inch	300 x 300 mm	30.0 x 30.0 cm	300 x 300 mm	300 x 300 mm	
WEIGHT	TV Only	32.6 kg / 71.9 lb	32.6 kg	Approx. 32.6 kg	Approx. 32.6 kg	Approx. 32.6 kg
	TV with Stand (Standard position)	33.8 kg / 74.5 lb	33.8 kg	Approx. 33.8 kg	Approx. 33.8 kg	Approx. 33.8 kg
	TV with Stand (Narrow position)	-	-	Approx. 33.8 kg	-	-
	TV with Stand (Soundbar position)	-	-	-	-	-
	TV with Stand (Front/Back position style)	-	-	-	-	-
	TV with Floor Stand	-	-	-	-	-
	Floor Stand weight (Supply)	-	-	-	-	-
Remarks		Main Stand (APH)	Main Stand (APH)	2way		

WITH STAND

MAIN STAND (STANDARD POSITION)  
EXCEPT KD-75X85K (NORTH AMERICA & LATIN AMERICA)

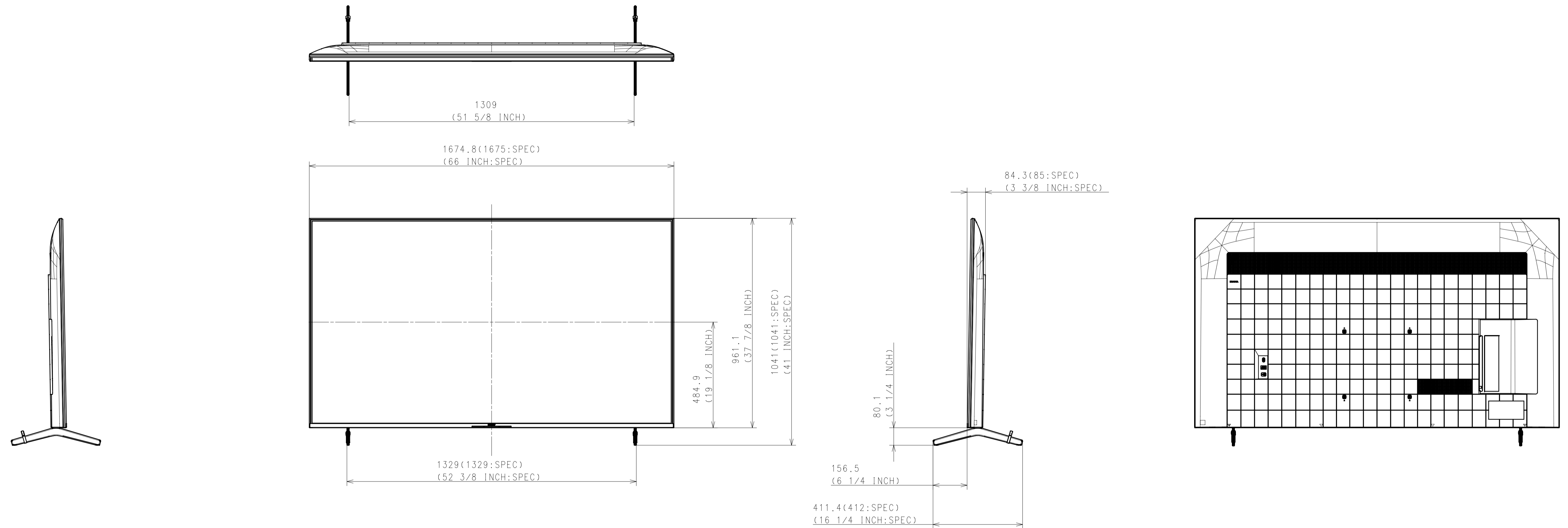

HISTORY 1. JASON LEE 2. JASON LEE 3. JASON LEE		SUFFIX 1. 001 2. 002 3. 003		RELEASE NO. 1. 001 2. 002 3. 003		REVISION 1. 001 2. 002 3. 003		DATE 1. 2021.12.13 2. 2021.12.13 3. 2021.12.13		SIGN. 1. JASON LEE 2. JASON LEE 3. JASON LEE		GENERAL TOLERANCE ±0.1mm (0.004 INCH)		DATE OF ISSUE 2021.12.13		DOCUMENT TYPE ASSEMBLY		TOOLERANCE DRAWING (JIS & ISO/IEC 8015)	
Sony Corporation										ORIGINAL MODEL 75(X85K) EXTERIOR VIEW		FINISH(COLOR) BLACK		DATE OF ISSUE 2021.12.13		DOCUMENT TYPE ASSEMBLY		TOOLERANCE DRAWING (JIS & ISO/IEC 8015)	
RESPONSIBLE DEPARTMENT PANEL & MECHANICAL DESIGN										TENTATIVE MODEL 75(X85K) EXTERIOR VIEW		FINISH(COLOR) BLACK		DATE OF ISSUE 2021.12.13		DOCUMENT TYPE ASSEMBLY		TOOLERANCE DRAWING (JIS & ISO/IEC 8015)	
DRAWN BY JASON LEE										SCALE 1:10		UNIT mm		DATE OF ISSUE 2021.12.13		DOCUMENT TYPE ASSEMBLY		TOOLERANCE DRAWING (JIS & ISO/IEC 8015)	
CHECKED BY JASON LEE										SIZE A1		SHEET/PAGES 1/5		DATE OF ISSUE 2021.12.13		DOCUMENT TYPE ASSEMBLY		TOOLERANCE DRAWING (JIS & ISO/IEC 8015)	

WITH STAND

NARROW POSITION  
KD-75X85K (EUROPE Model only)

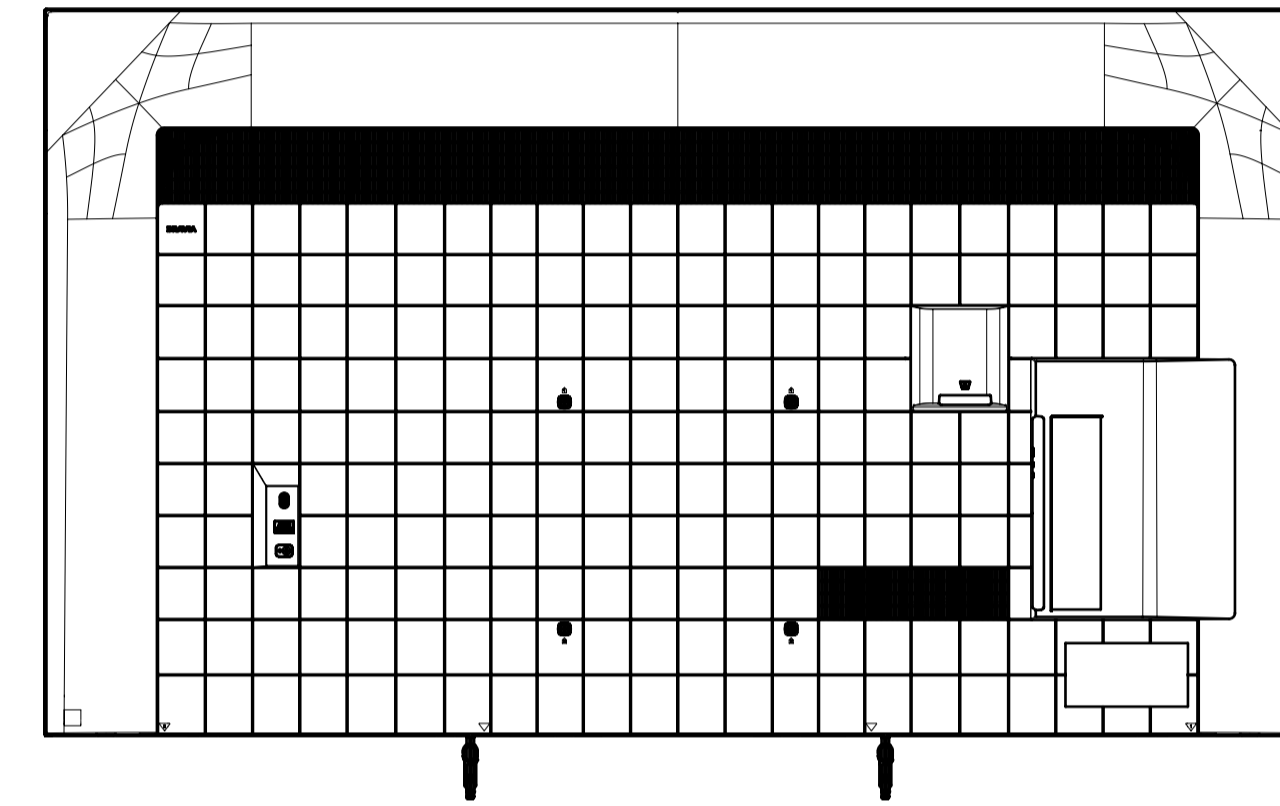
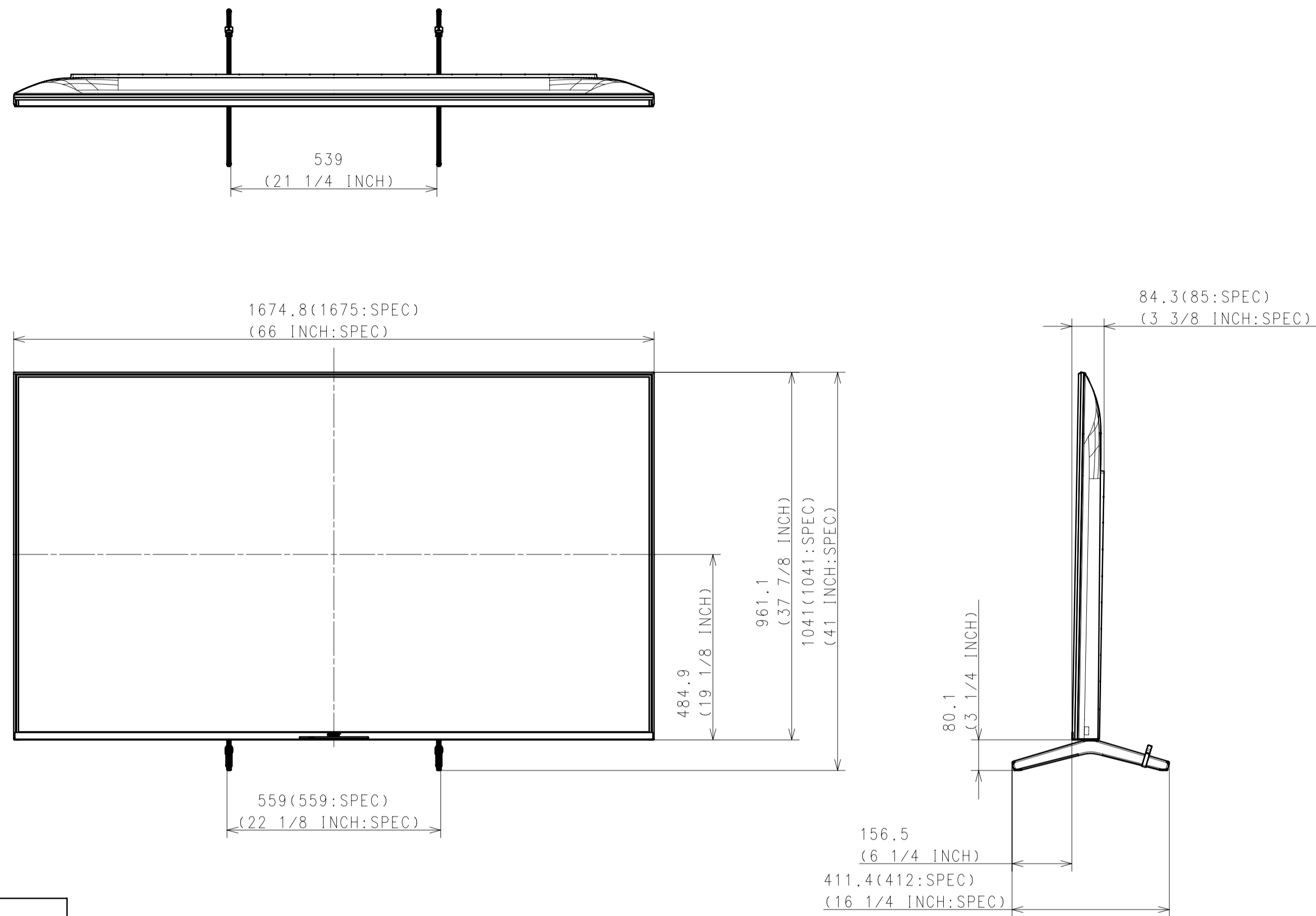

WITH STAND

MAIN STAND (APH)  
STANDARD POSITION  
KD-75X85K (NORTH AMERICA & LATIN AMERICA)

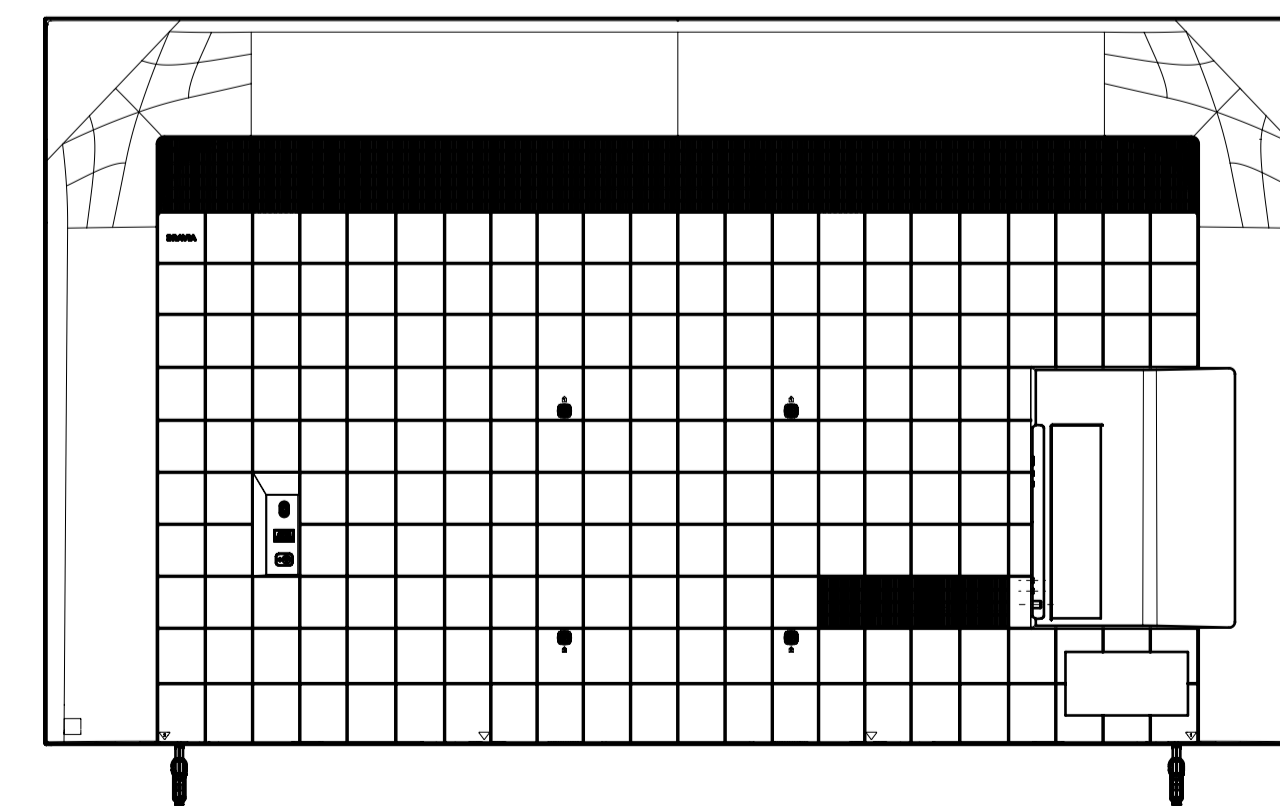
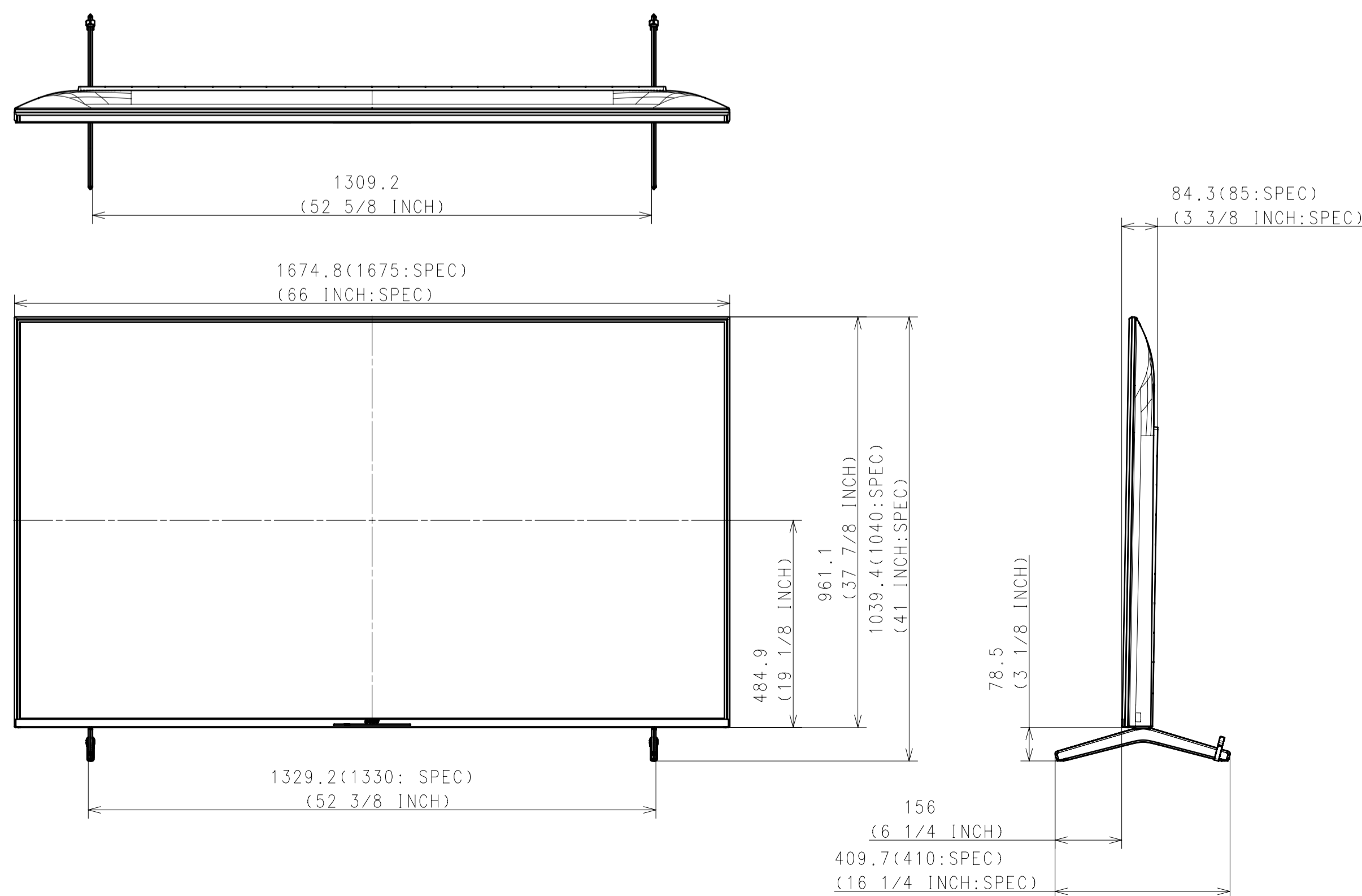

DESCRIPTION 1	LEGAL OWNER	SCALE
75(X85K) EXTERIOR VIEW	Sony Corporation	1:10
DESCRIPTION 2	PART NO.	SHEET/PAGES
75(X85K) EXTERIOR VIEW		2 / 5

WITHOUT STAND

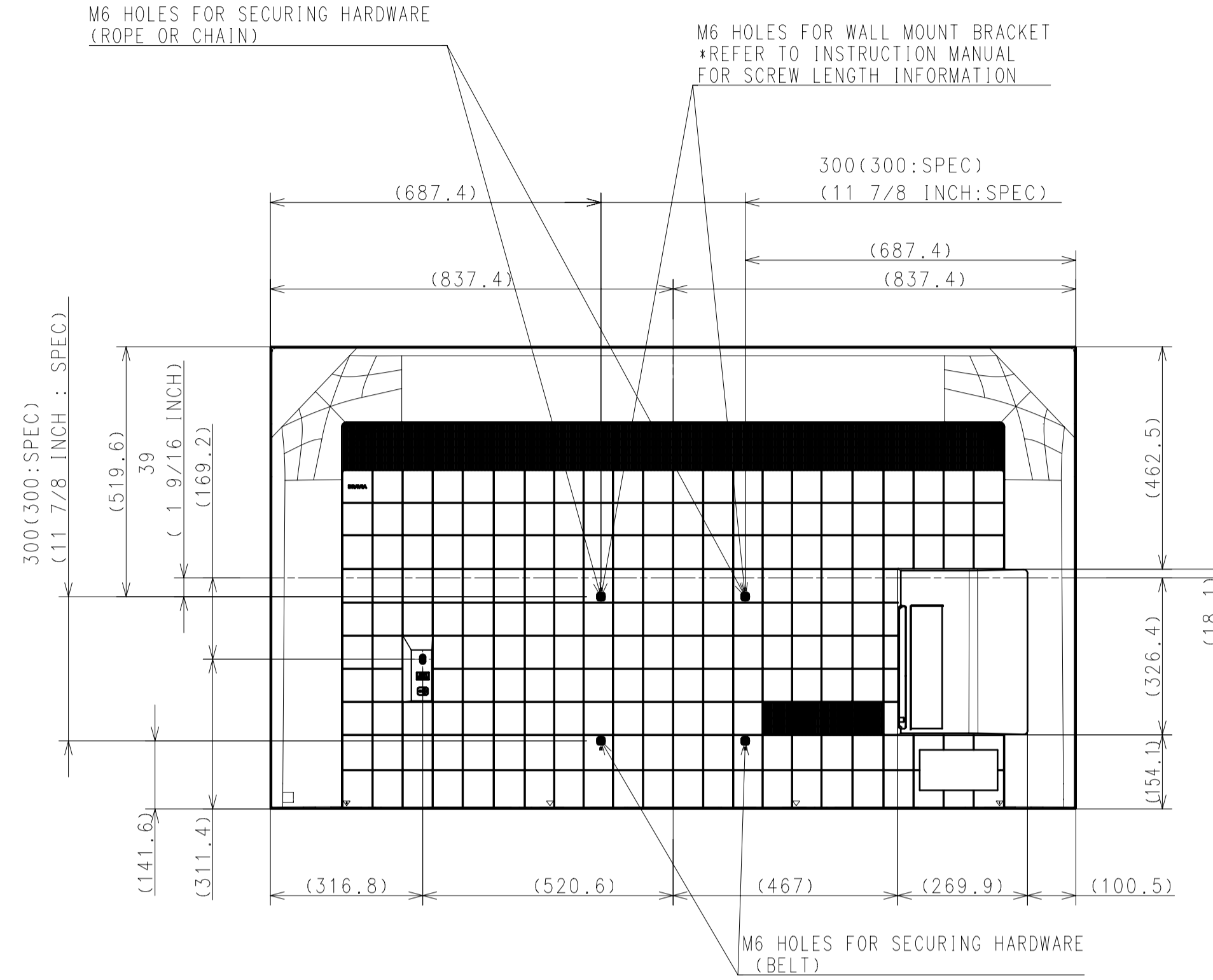
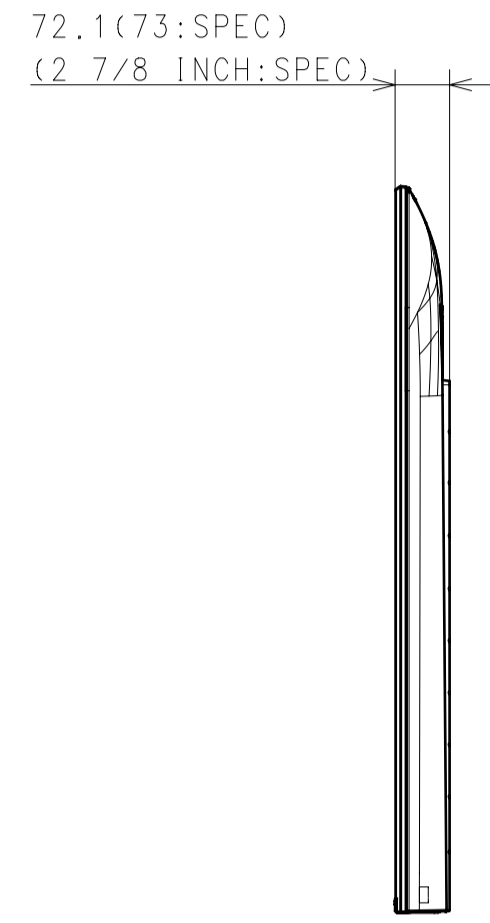
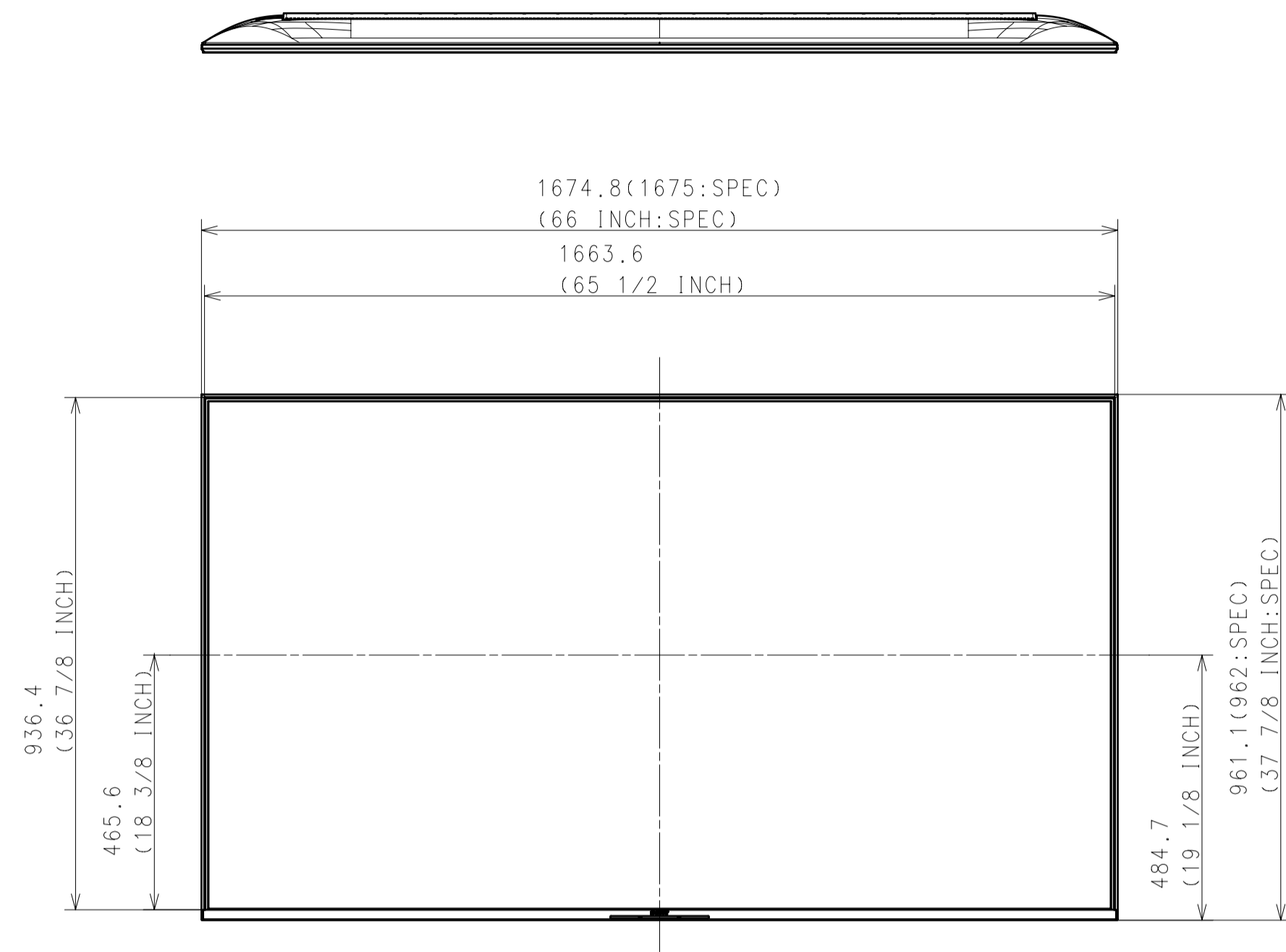

For NORTH AMERICA, GENERAL AREA, CHINA

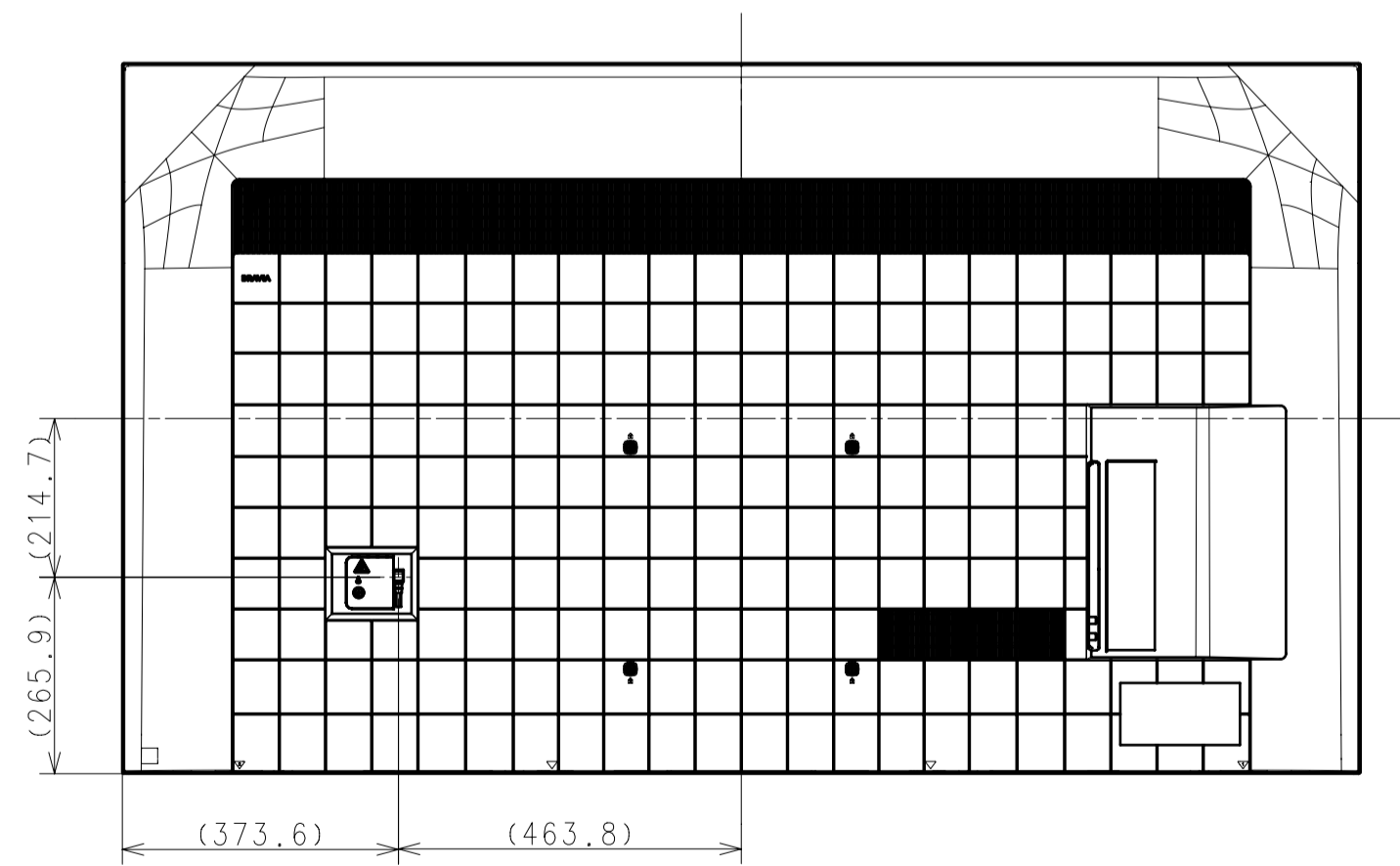

For LATIN AMERICA

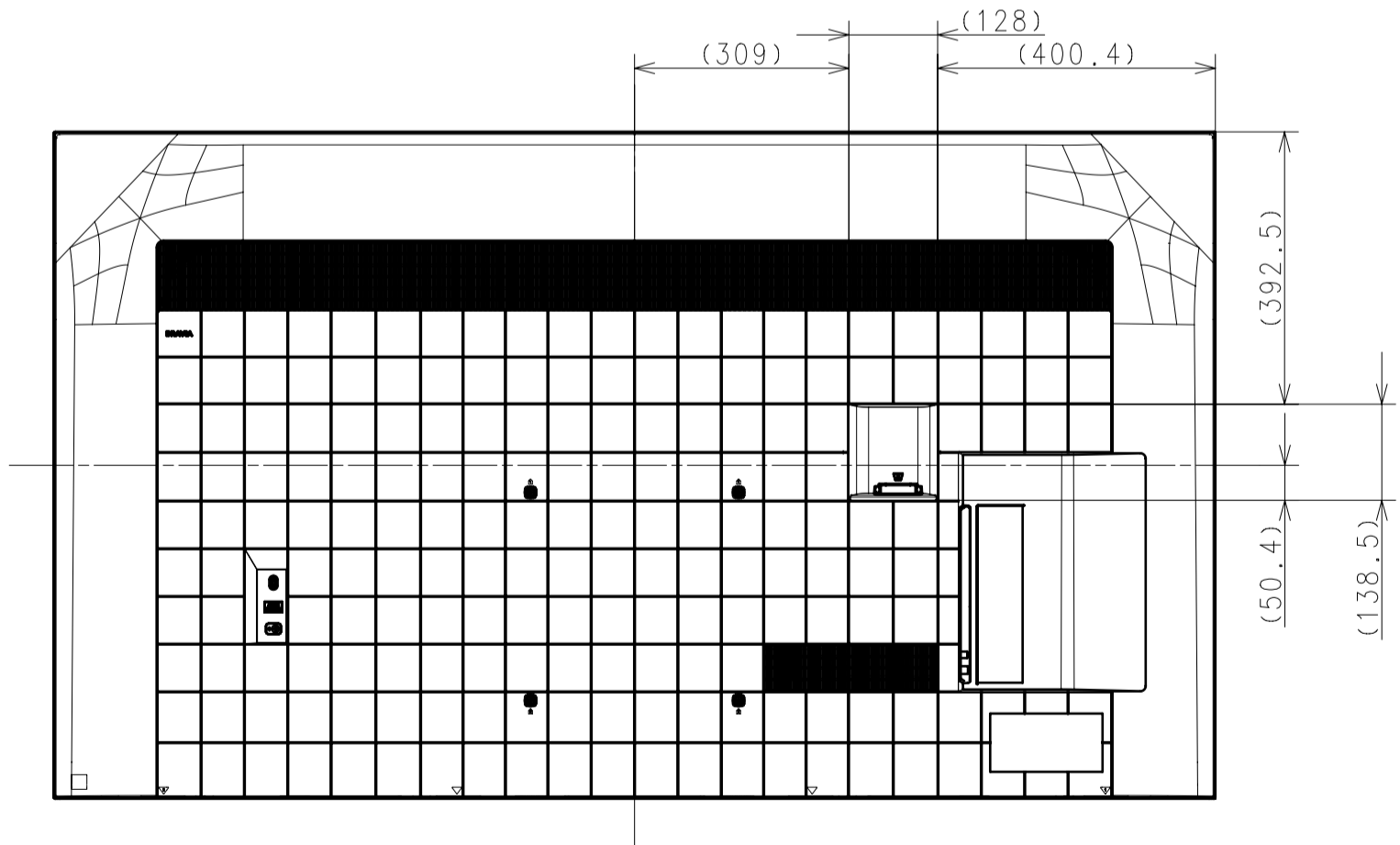

For EUROPE

DESCRIPTION 1	LEGAL OWNER	SCALE
75(X85K) EXTERIOR VIEW	Sony Corporation	1:10
DESCRIPTION 2	PART NO.	SHEET/PAGES
75(X85K) EXTERIOR VIEW		3 / 5

SU-WL450

STANDARD

SLIM

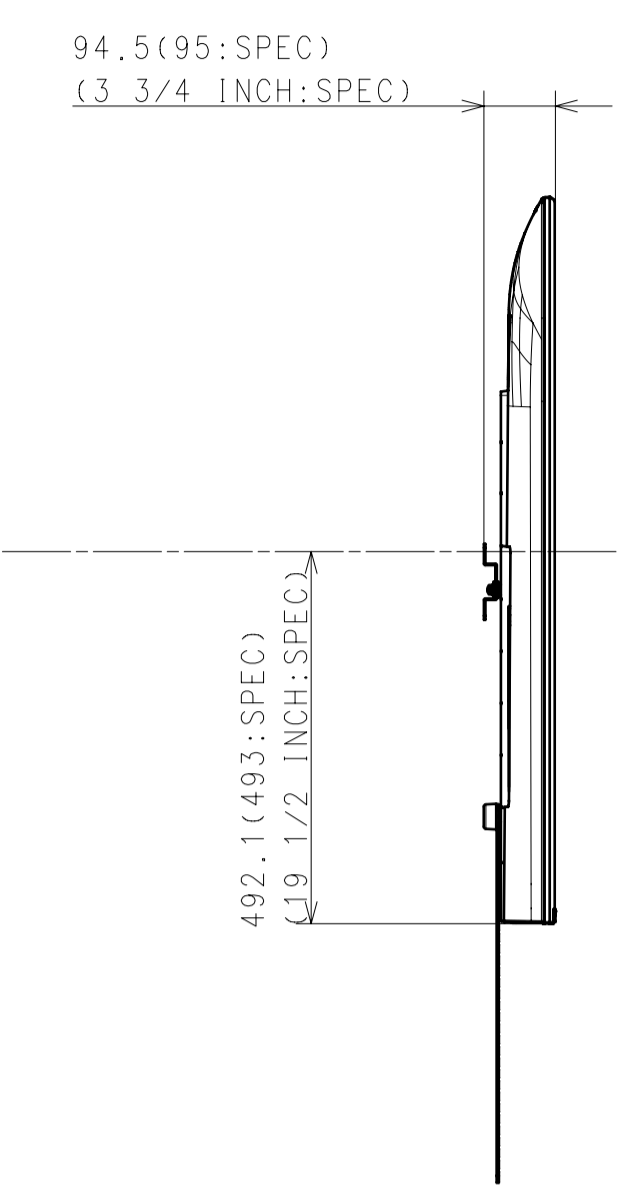
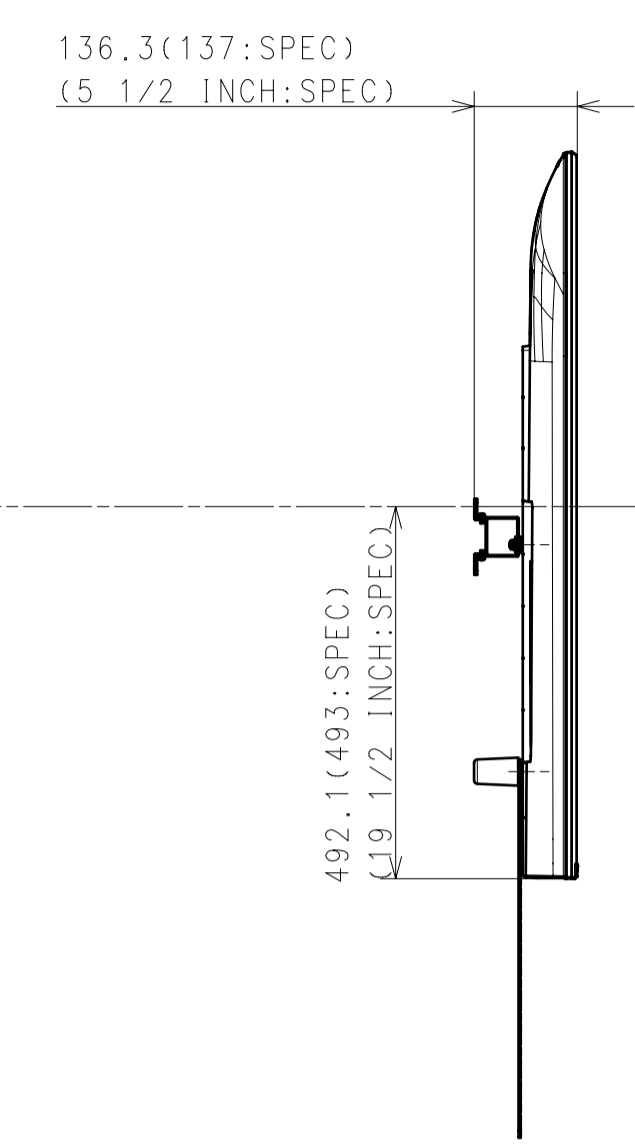
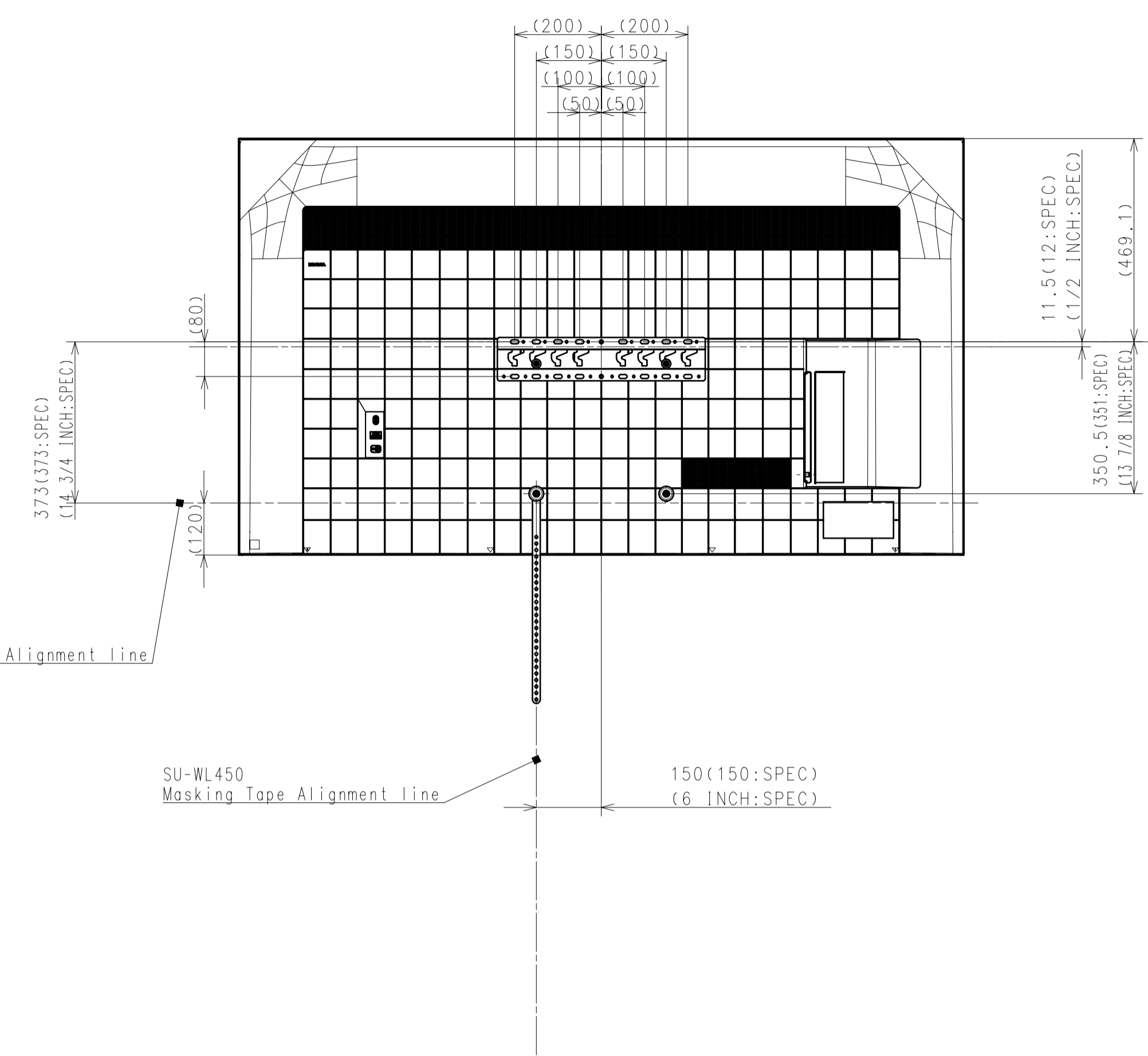

SONY STANDARD

DESCRIPTION 1	LEGAL OWNER	SCALE
75(X85K) EXTERIOR VIEW	Sony Corporation	1:10
DESCRIPTION 2	PART NO.	SHEET/PAGES
75(X85K) EXTERIOR VIEW		4 / 5

SU-WL 850

SU-WL 855 WITH LATERAL SHAFT BRACKET

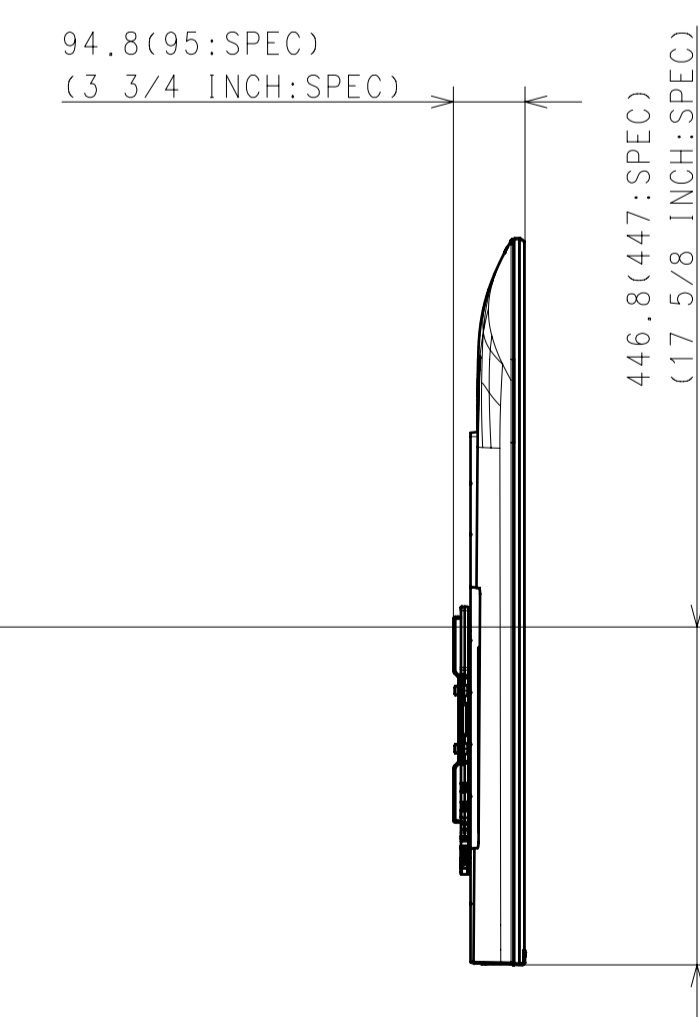
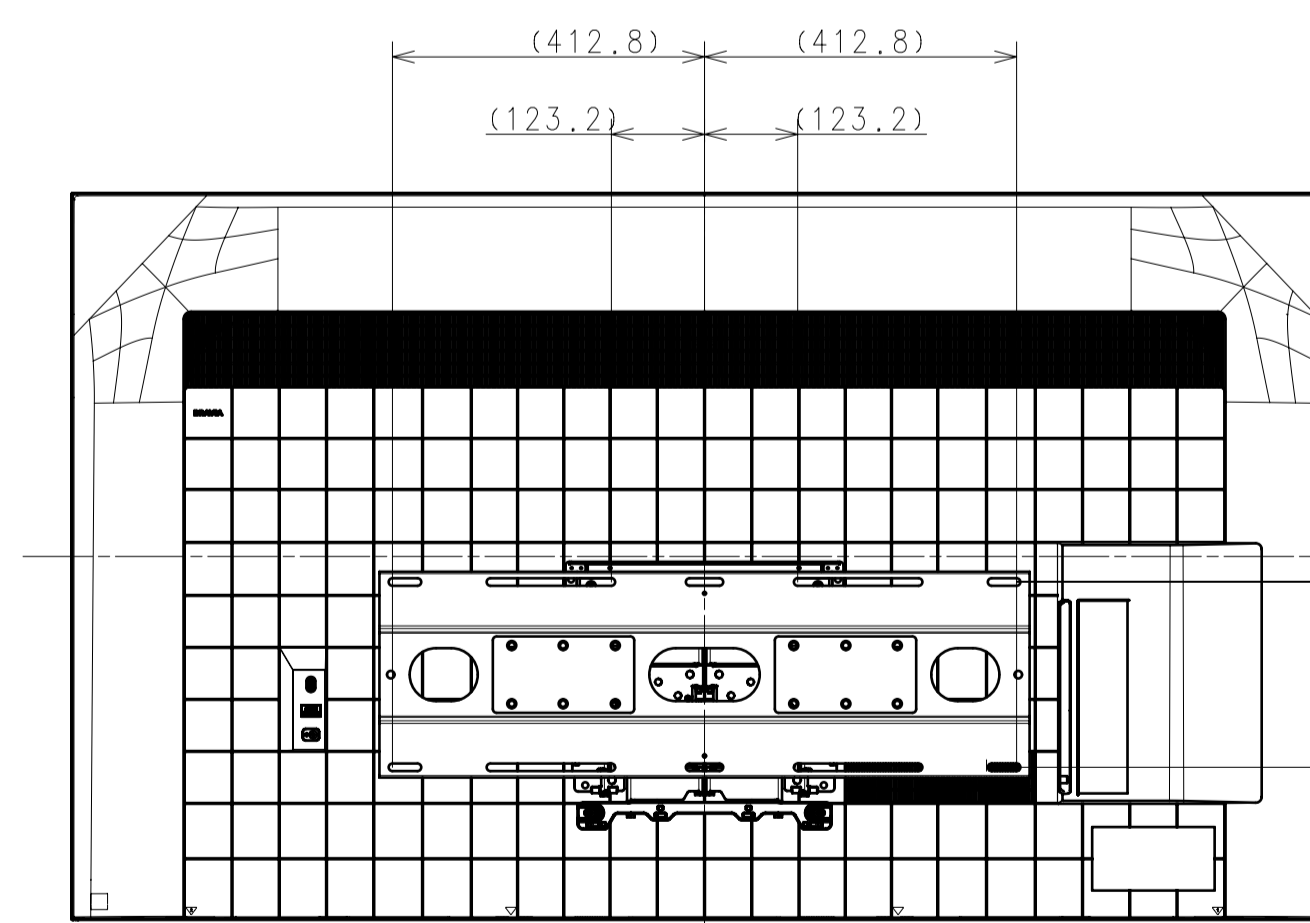
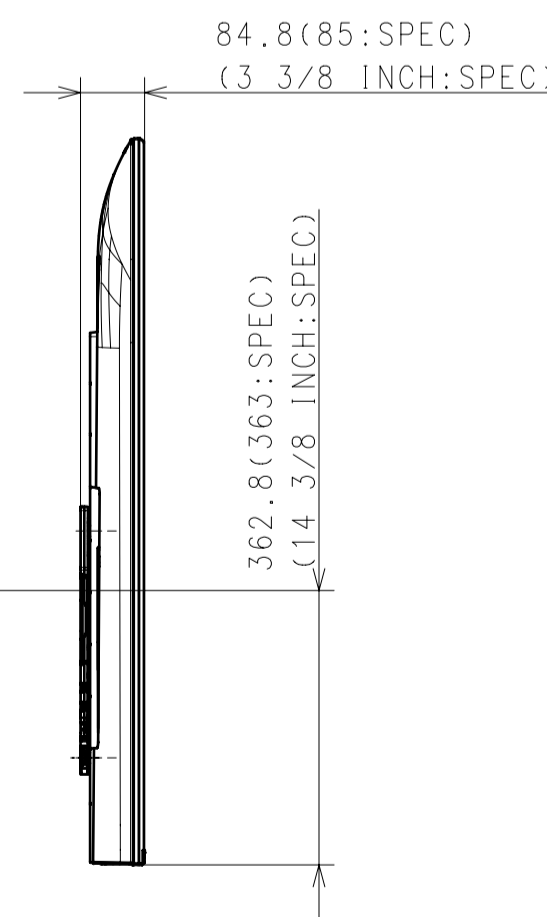
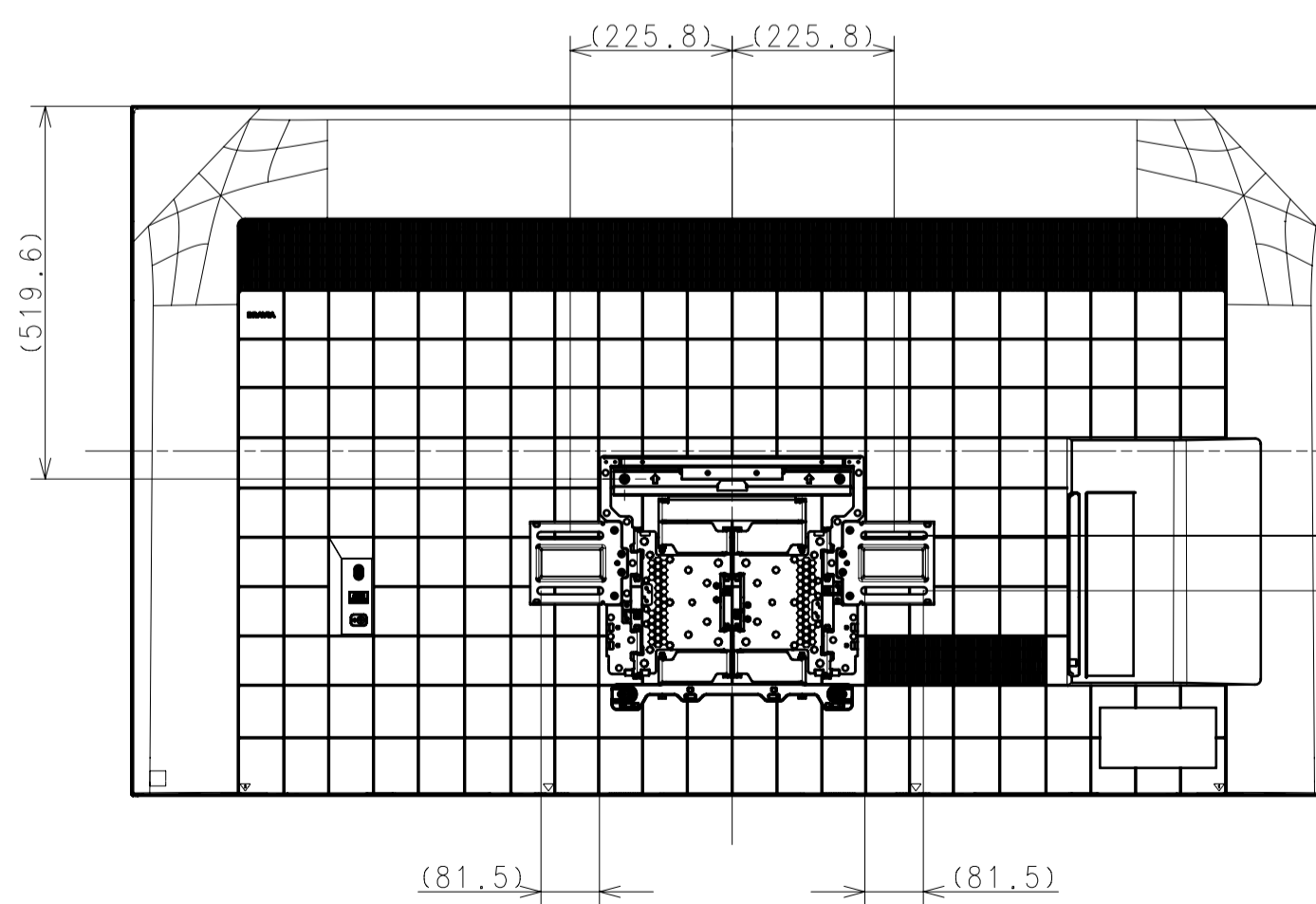
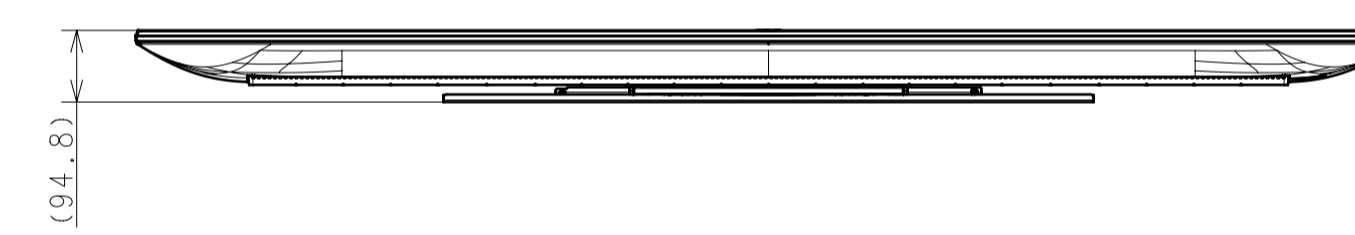
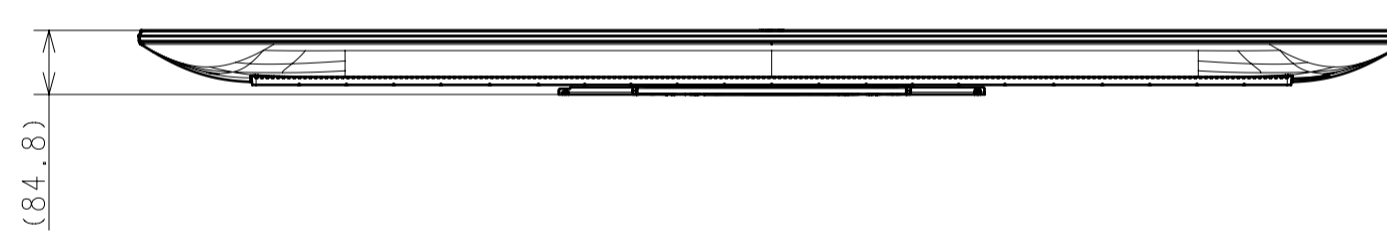
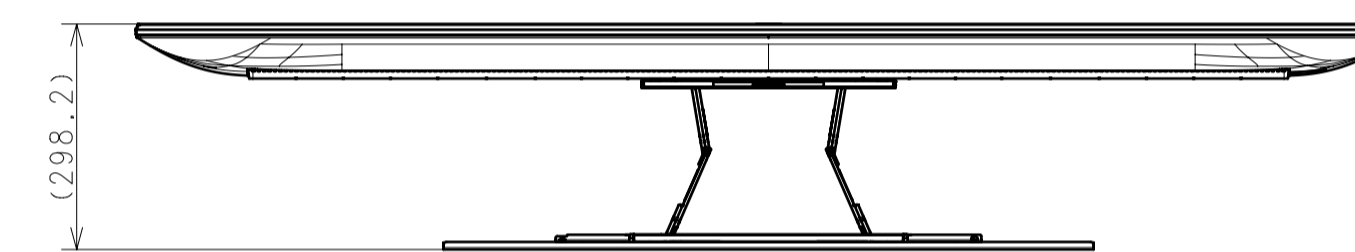
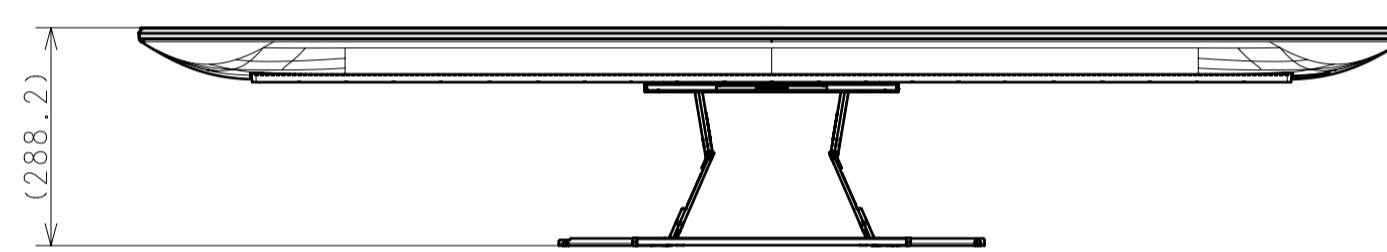
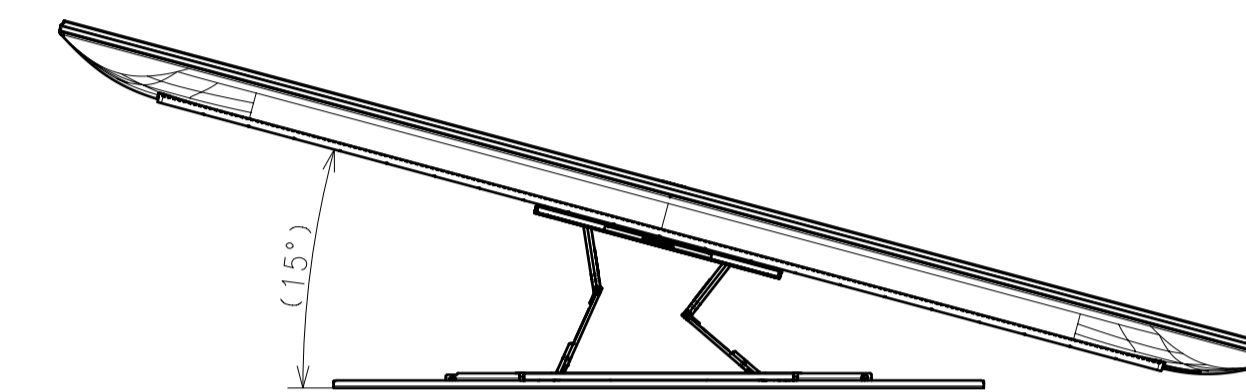
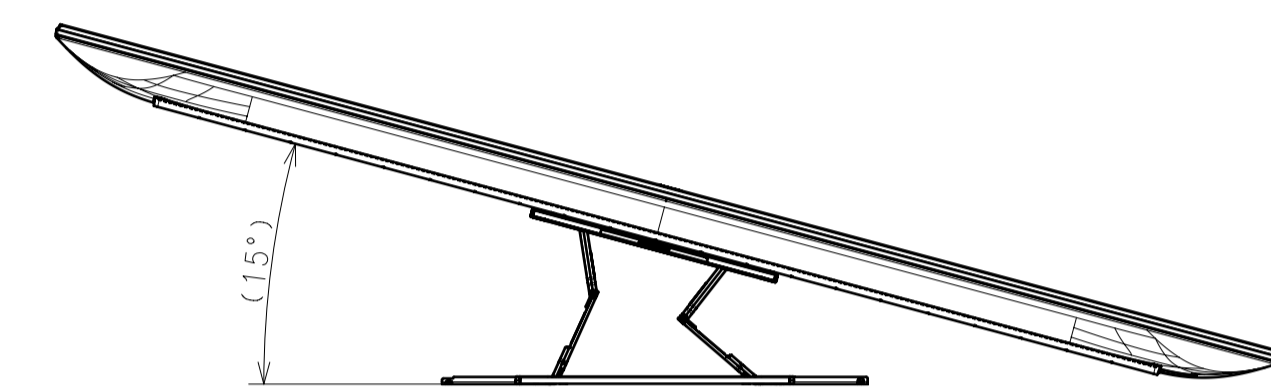
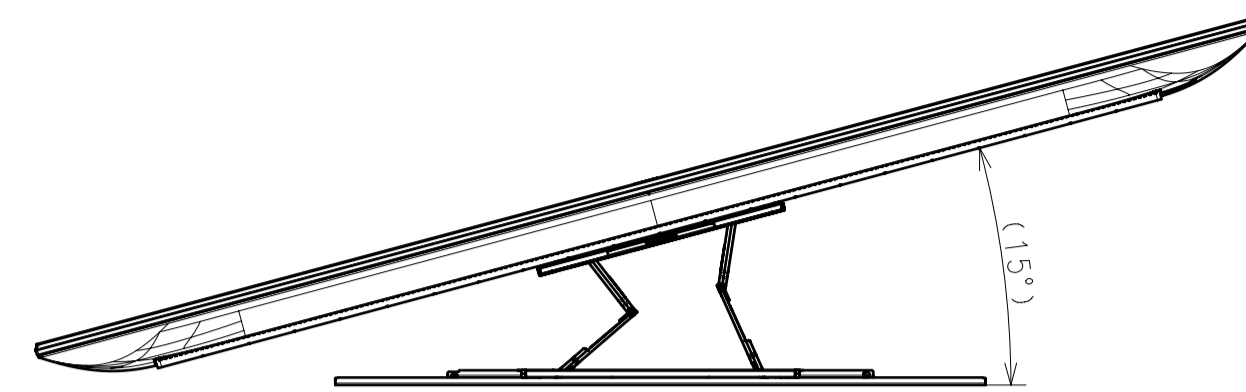
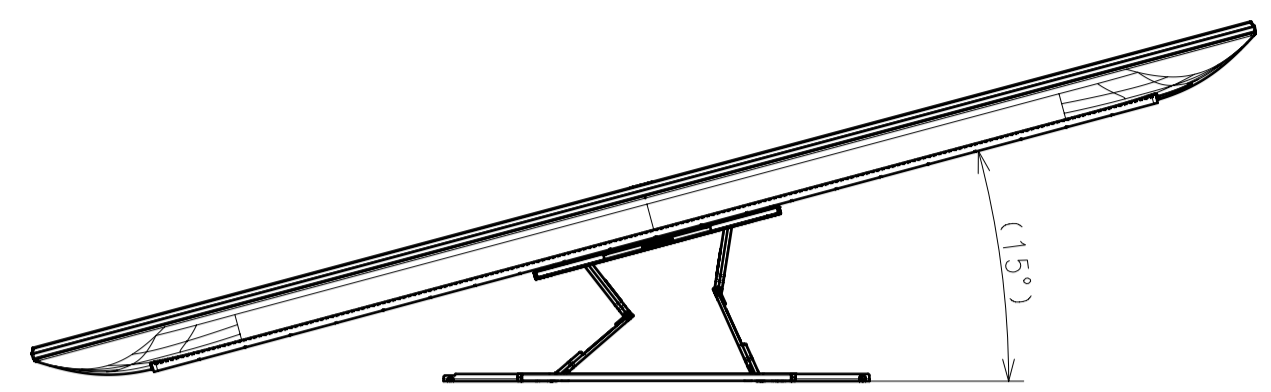

DESCRIPTION 1	LEGAL OWNER	SCALE
75(X85K) EXTERIOR VIEW	Sony Corporation	1:10
DESCRIPTION 2	PART NO.	SHEET/PAGES
75(X85K) EXTERIOR VIEW		5 / 5