

Area	NORTH AMERICA	EUROPE	GENERAL AREA	CHINA
Model Name	XR-75Z9J	XR-75Z9J	XR-75Z9J	XR-75Z9J
SV No.	SV-39012	SV-39141	SV-39054	SV-39097
DIMENSION	TV only (W x H x D)	1681 x 982 x 81(37.6) mm / 66 1/4 x 38 3/4 x 3 1/4(1 1/2) inch	Approx. 168.1 x 98.2 x 8.1(3.76) cm	Approx. 1681 x 982 x 81(37.6) mm
	TV with Stand (Standard position) (W x H x D)	1711 x 993 x 428 mm / 67 3/8 x 39 1/8 x 16 7/8 inch	Approx. 171.1 x 99.3 x 42.8 cm	Approx. 1711 x 993 x 428 mm
	TV with Stand (Narrow position) (W x H x D)	1681 x 1012 x 428 mm / 66 1/4 x 39 7/8 x 16 7/8 inch	Approx. 168.1 x 101.2 x 42.8 cm	Approx. 1681 x 1012 x 428 mm
	TV with Stand (Soundbar position) (W x H x D)	1711 x 1067 x 428 mm / 67 3/8 x 42 1/8 x 16 7/8 inch	Approx. 171.1 x 106.7 x 42.8 cm	Approx. 1711 x 1067 x 428 mm
	TV with Floor Stand (W x H x D)	-	-	-
	Stand Width (Standard position)	1711 mm / 67 3/8 inch	Approx. 171.1 cm	Approx. 1711 mm
	Stand Width (Narrow position)	627 mm / 24 3/4 inch	Approx. 62.7 cm	Approx. 627 mm
	Stand Width (Soundbar position)	1711 mm / 67 3/8 inch	Approx. 171.1 cm	Approx. 1711 mm
WEIGHT	Floor Stand Width	-	-	-
	VESA Hole Pitch	400 x 400 mm / 15 3/4 x 15 3/4 inch	40.0 x 40.0 cm	400x400 mm
	TV Only	46.4 kg / 102.3 lb	Approx. 46.4 kg	Approx. 46.4 kg
	TV with Stand (Standard position)	48 kg / 105.8 lb	Approx. 48 kg	Approx. 48 kg
	TV with Stand (Narrow position)	48 kg / 105.8 lb	Approx. 48 kg	Approx. 48 kg
	TV with Stand (Soundbar position)	48 kg / 105.8 lb	Approx. 48 kg	Approx. 48 kg
Remarks	TV with Floor Stand	-	-	-
	Floor Stand weight (Supply)	-	-	-
	W-M't Br. Weight (Supply)	-	-	-

WITH STAND  
STANDARD POSITION

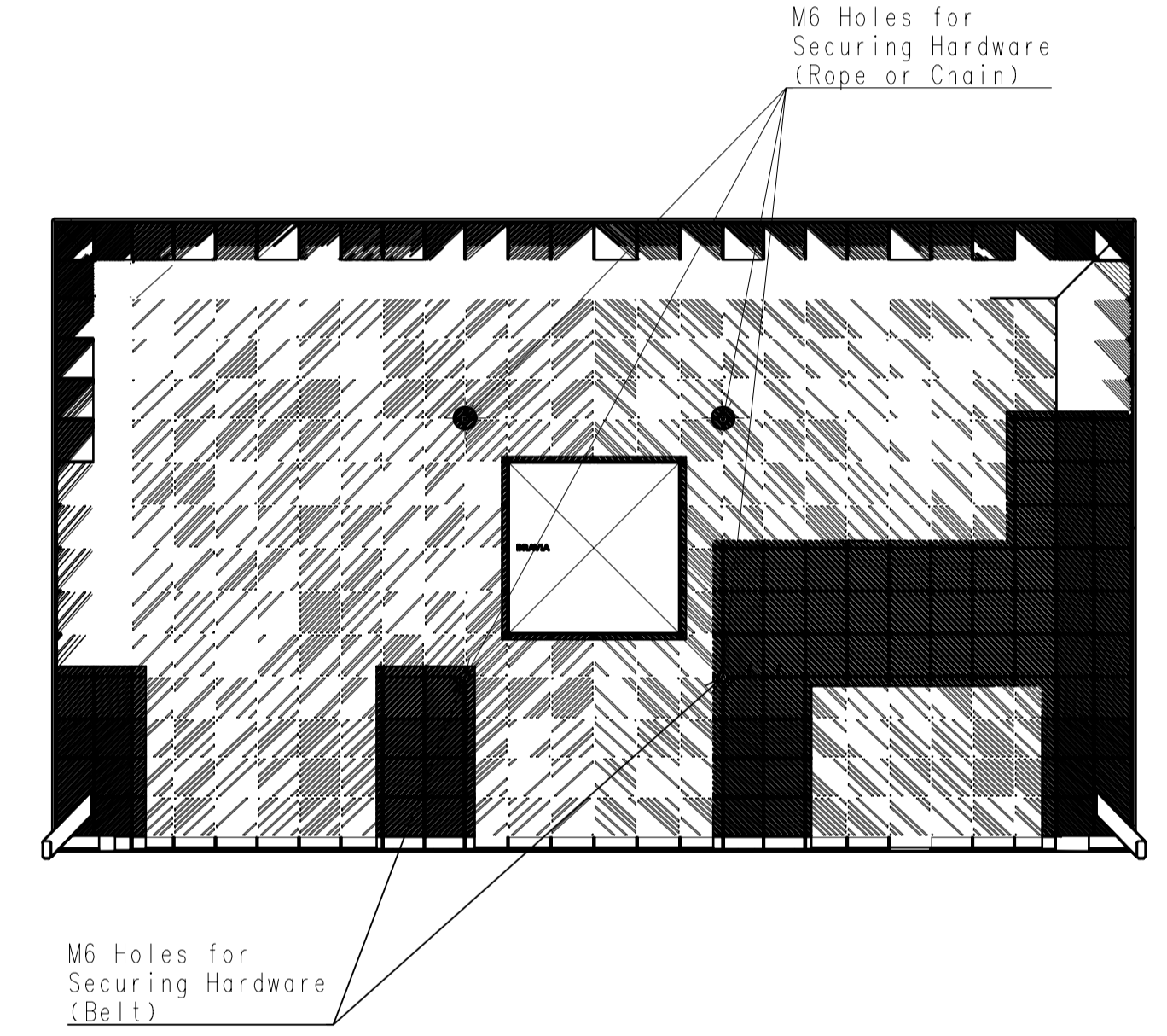
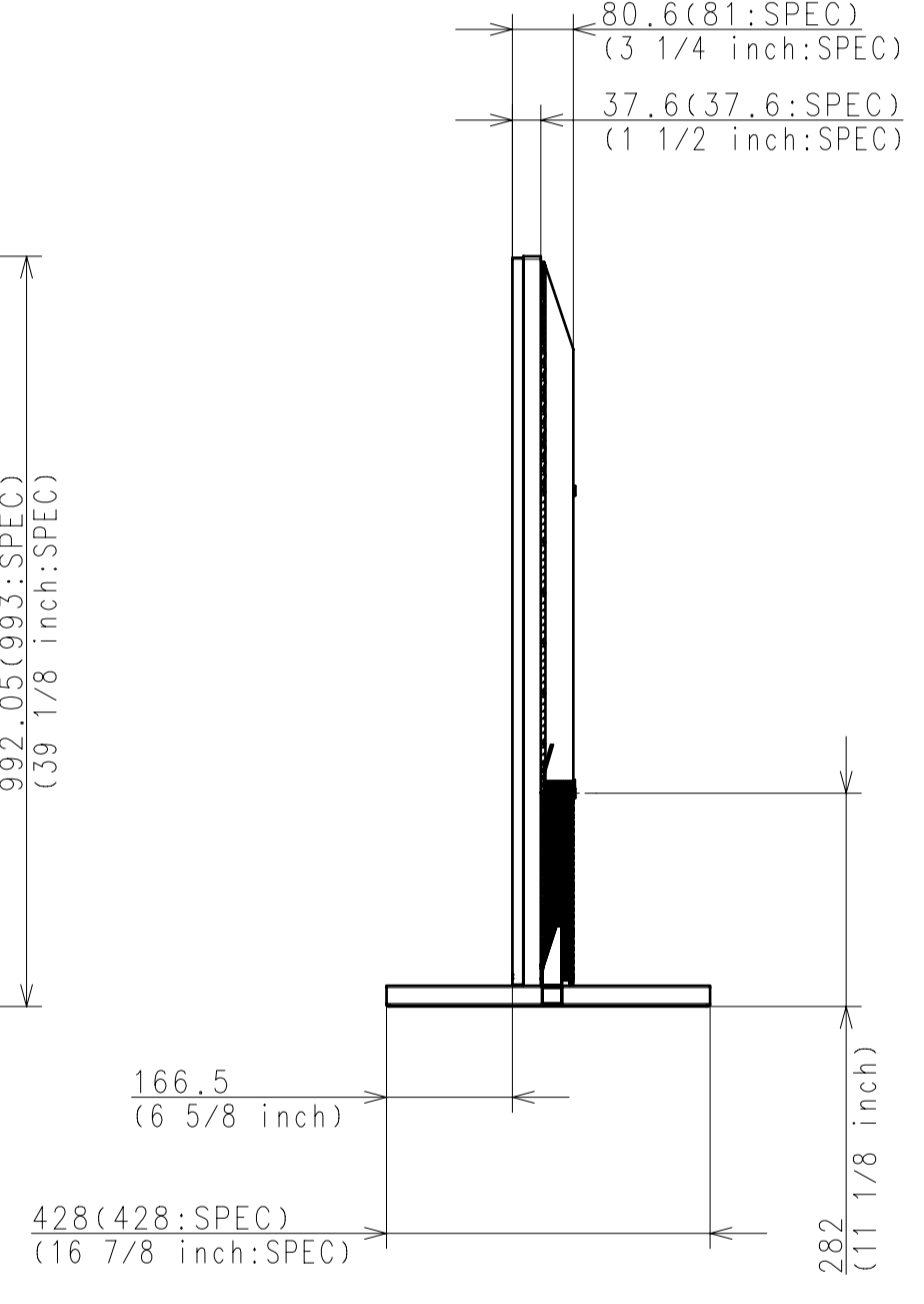
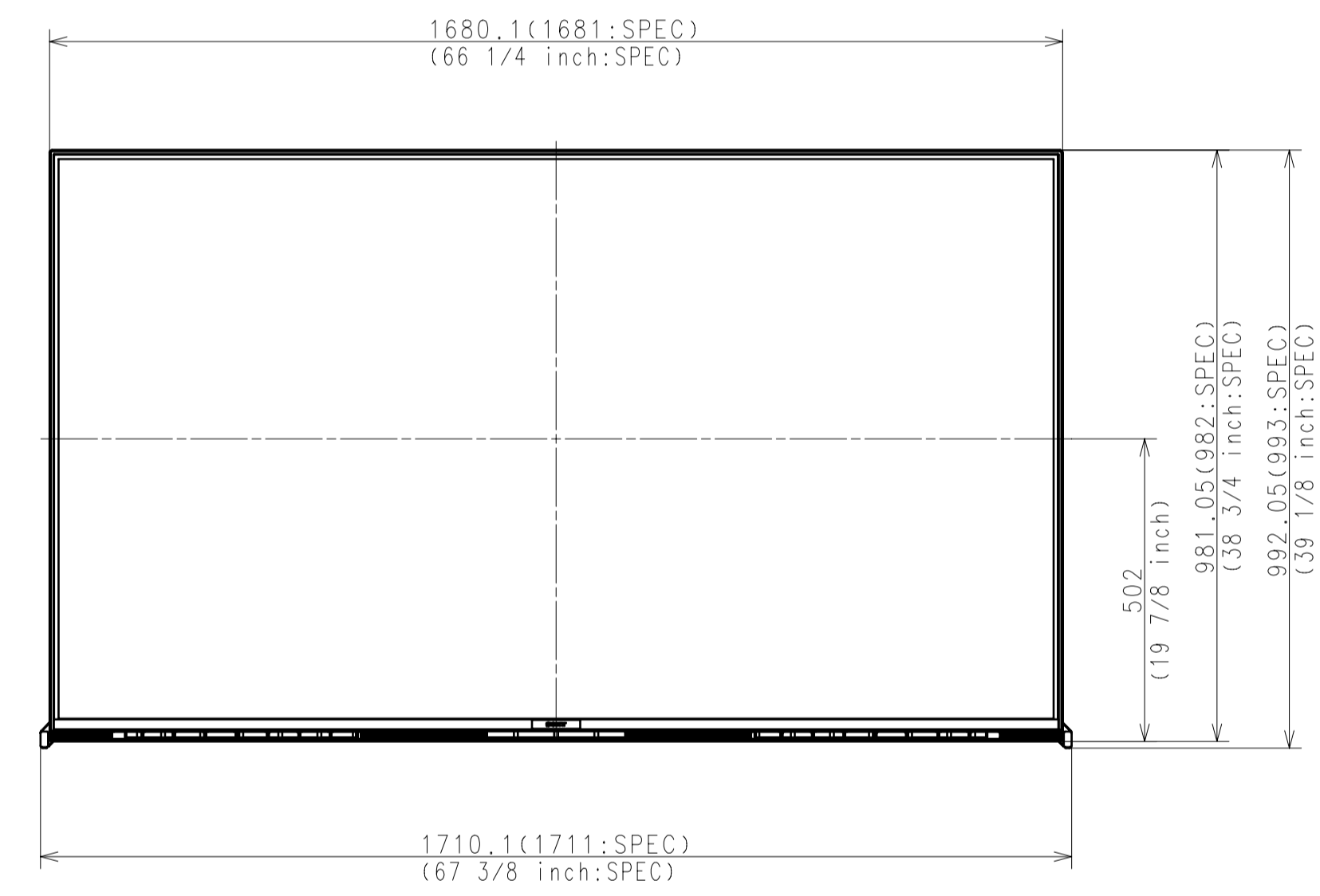
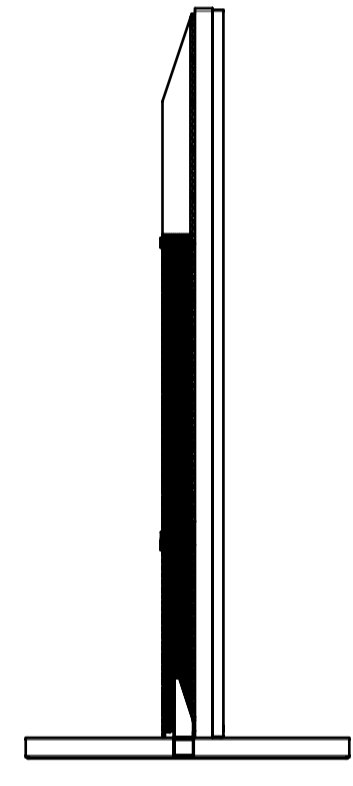

Purchase recycled resins and wire rods only from the business partners that Sony approves as Green Partners.  
再生樹脂・銅線はグリーンパートナー 認定者からの調達を心がけてください。

HISTORY X COUNT    SUFFIX (REV. NO.)    RELEASE NO.    DATE    REVISION    SIGN.		GENERAL TOLERANCE DATE OF ISSUE
LEGAL OWNER Sony Corporation		MATERIAL COLOR FINISH COLOR
RESPONSIBLE DEPARTMENT PLANNED BY    CHECKED BY    APPROVED BY    SCALE    TENTATIVE MODEL		DOCUMENT TYPE PART
DRAWN BY    SIZE    UNIT    PART NO.    SUFFIX    REV. NO.    SHEET/PAGES		TOOLERANCE DRAWING (JIS & ISO/IEC15001)
ORIGINAL MODEL 75(Z9J) EXTERIOR VIEW		DESCRIPTION 75(Z9J) EXTERIOR VIEW
1:10    A1    mm    1/3		1/3

WITH STAND

NARROW POSITION

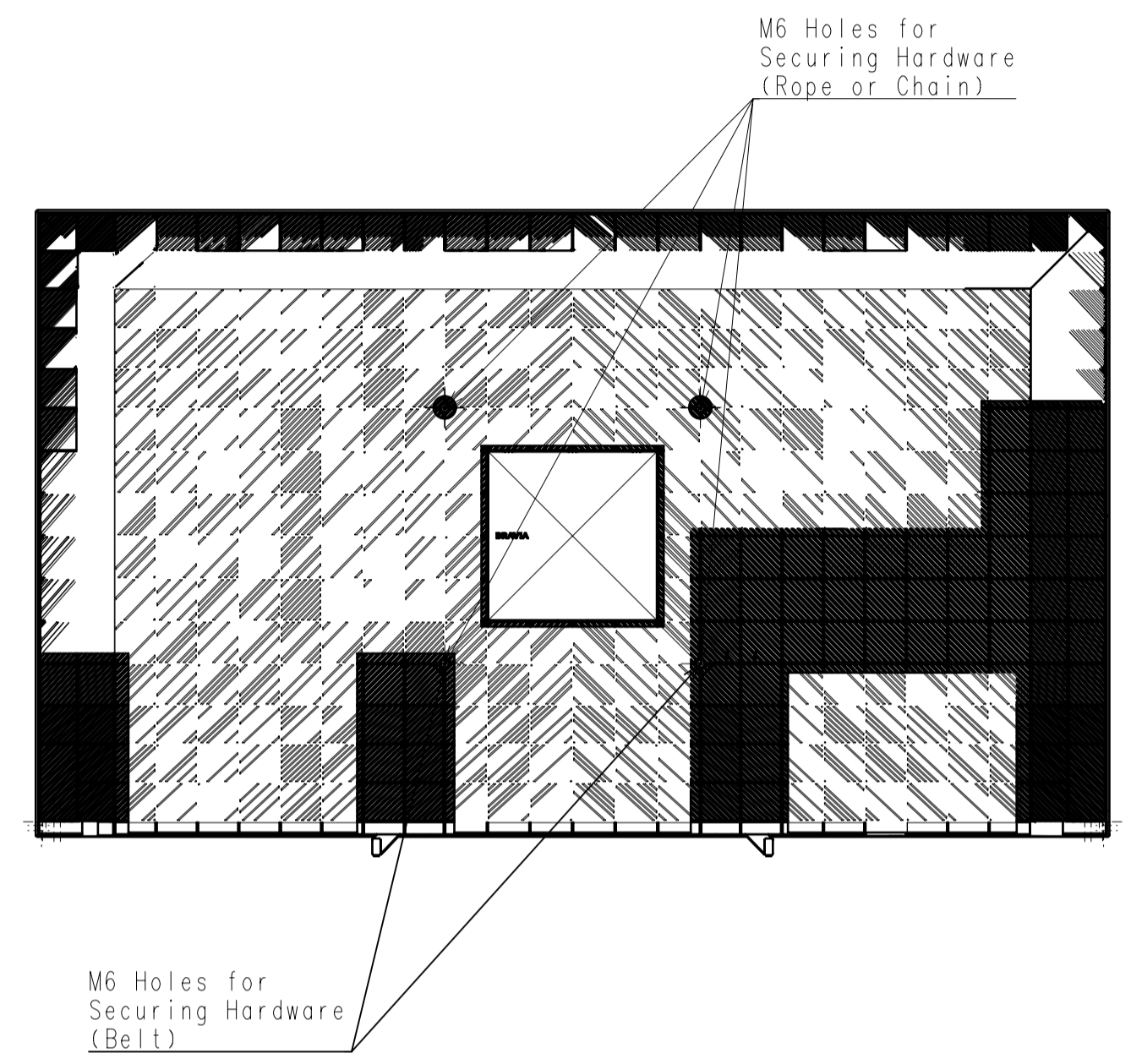
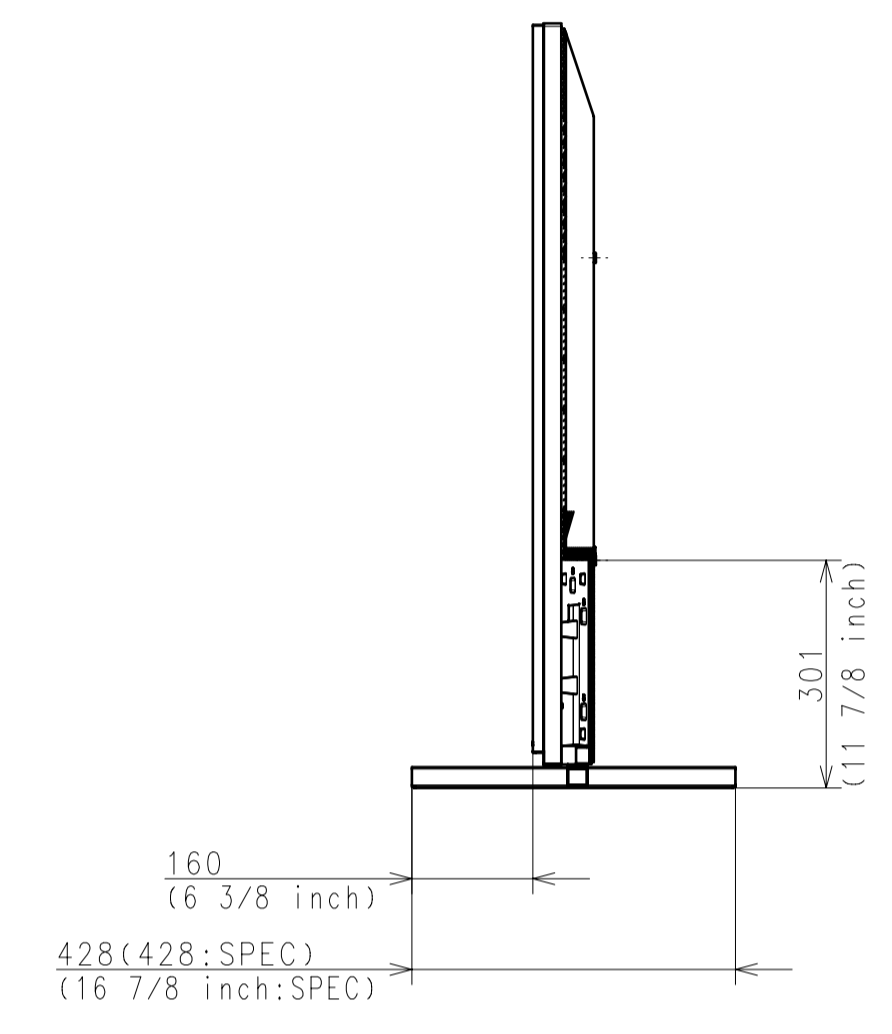
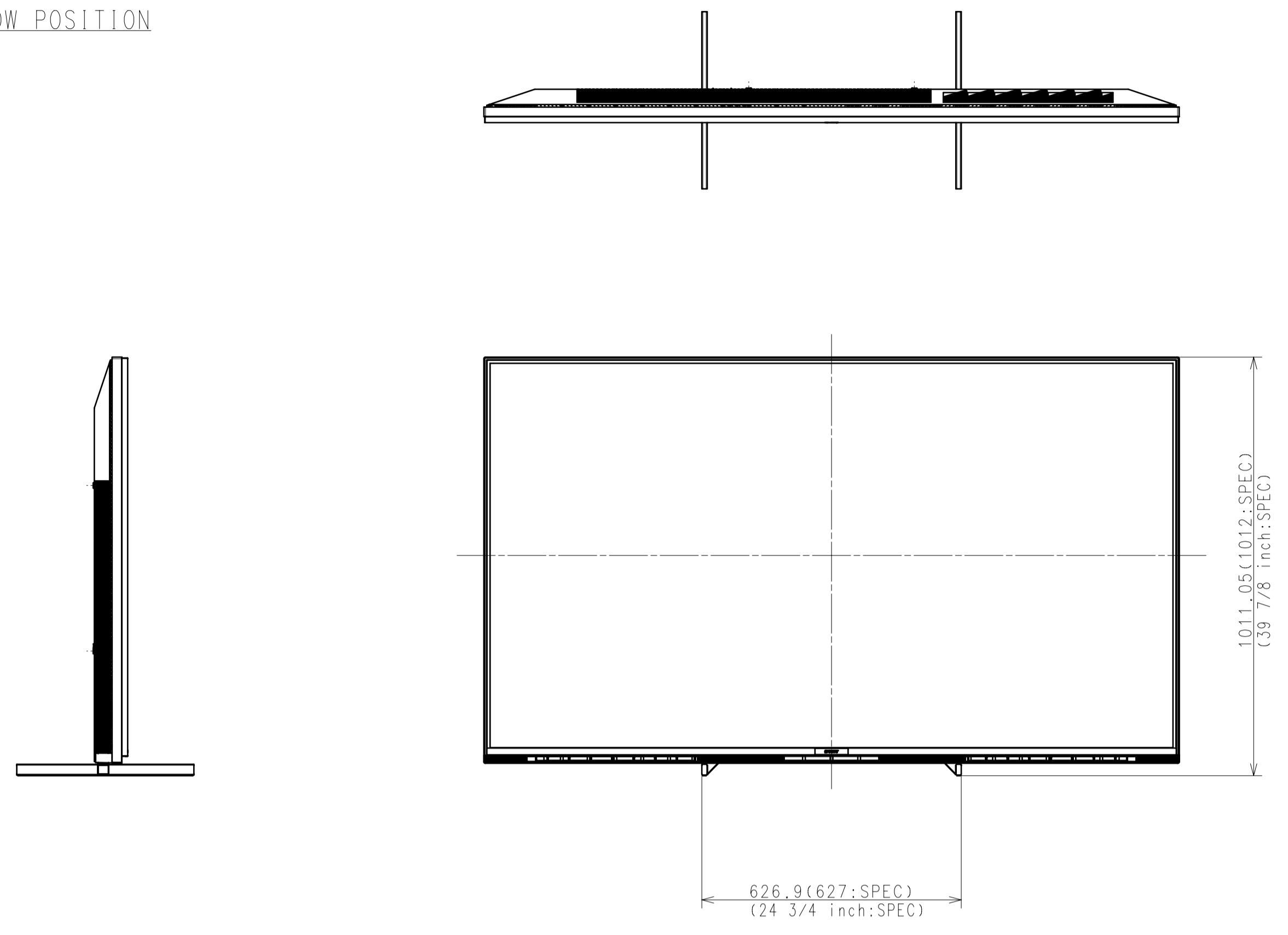

SOUNDBAR POSITION

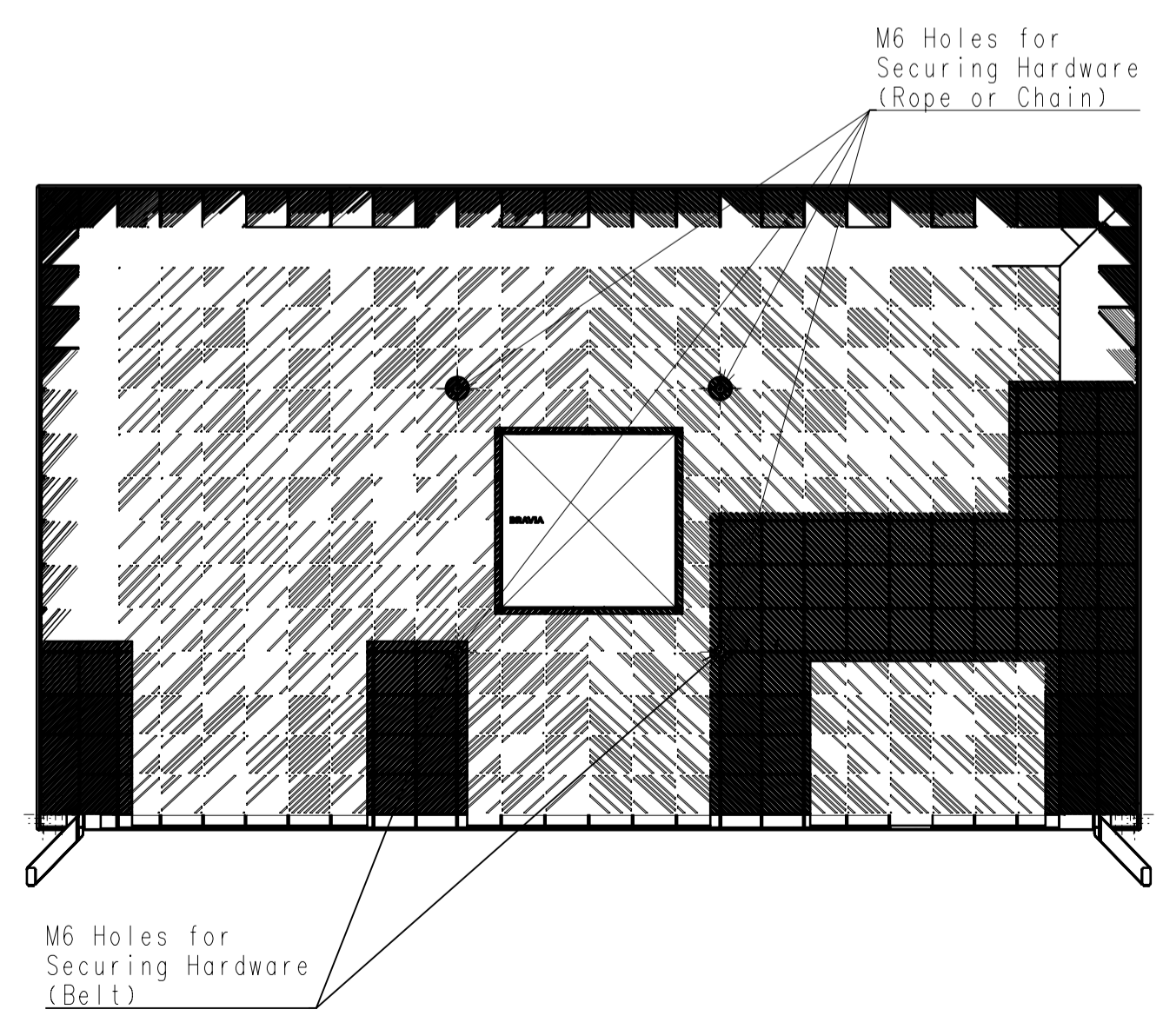
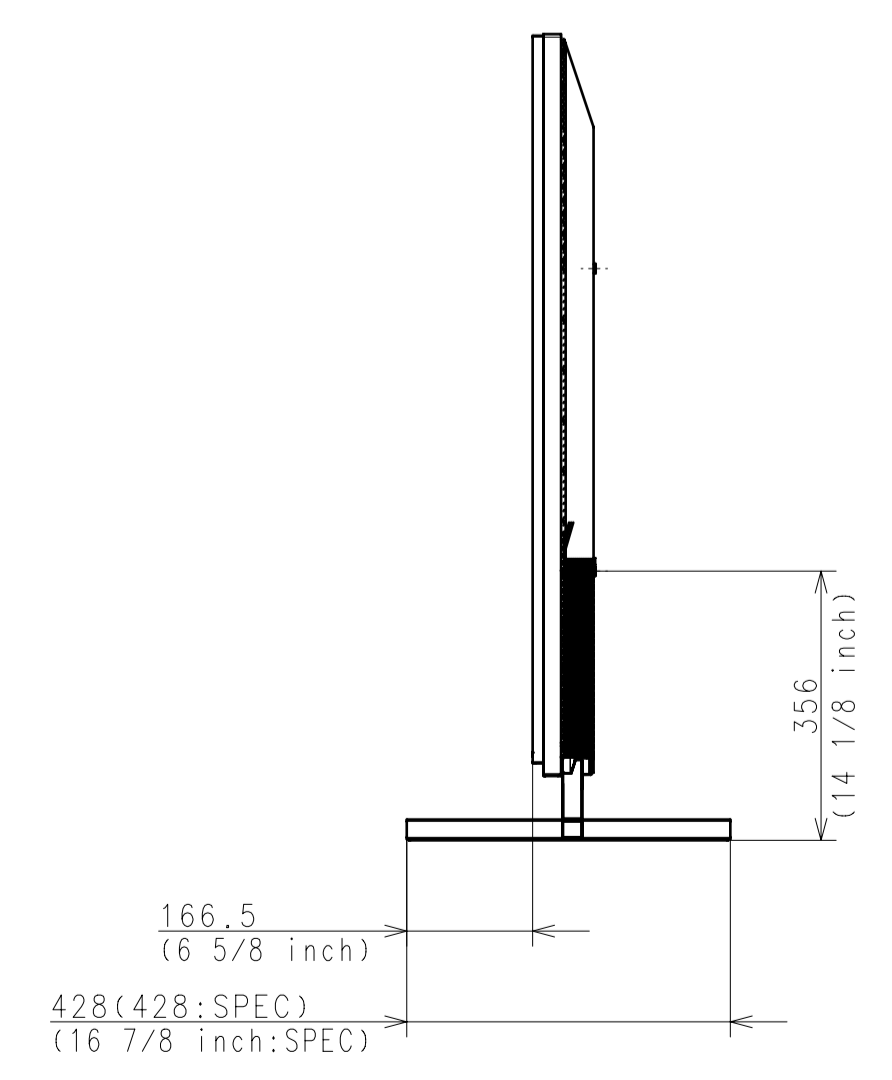
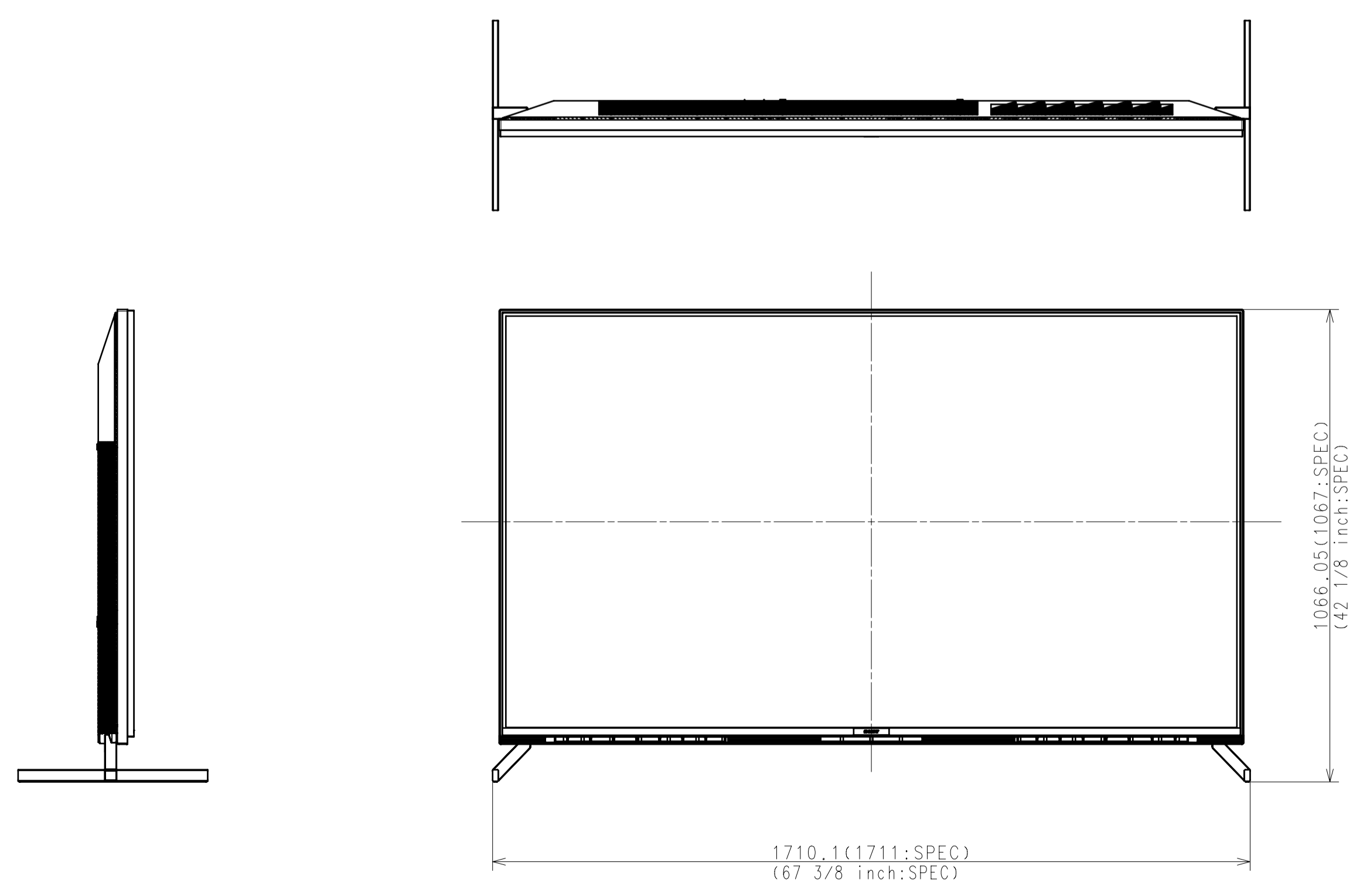

DESCRIPTION 1	75(Z9J) EXTERIOR VIEW	LEGAL OWNER	Sony Corporation	SCALE	1:10
DESCRIPTION 2	75(Z9J) EXTERIOR VIEW	PART NO.		SHEET/PAGES	2 / 3

WITHOUT STAND

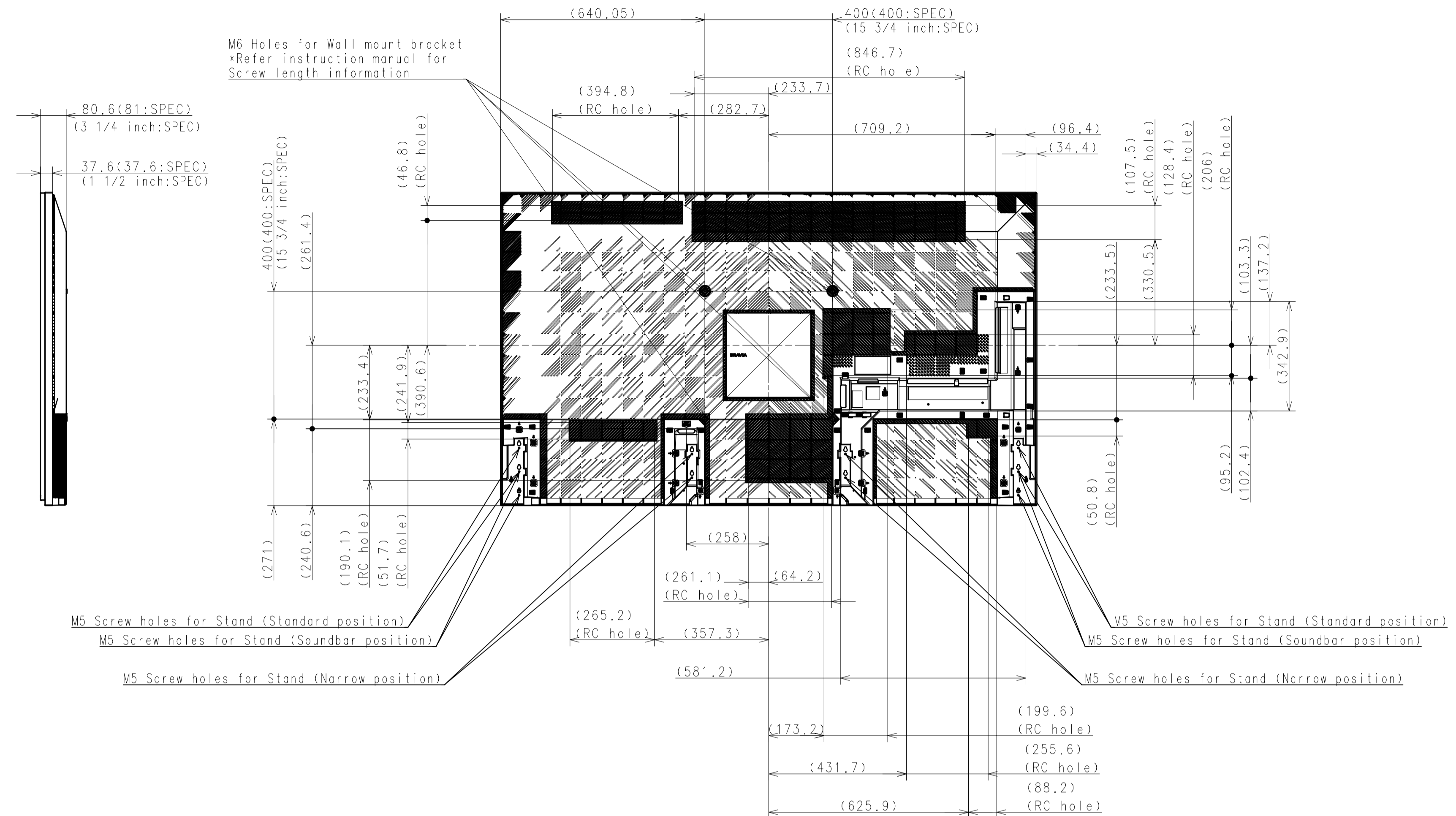
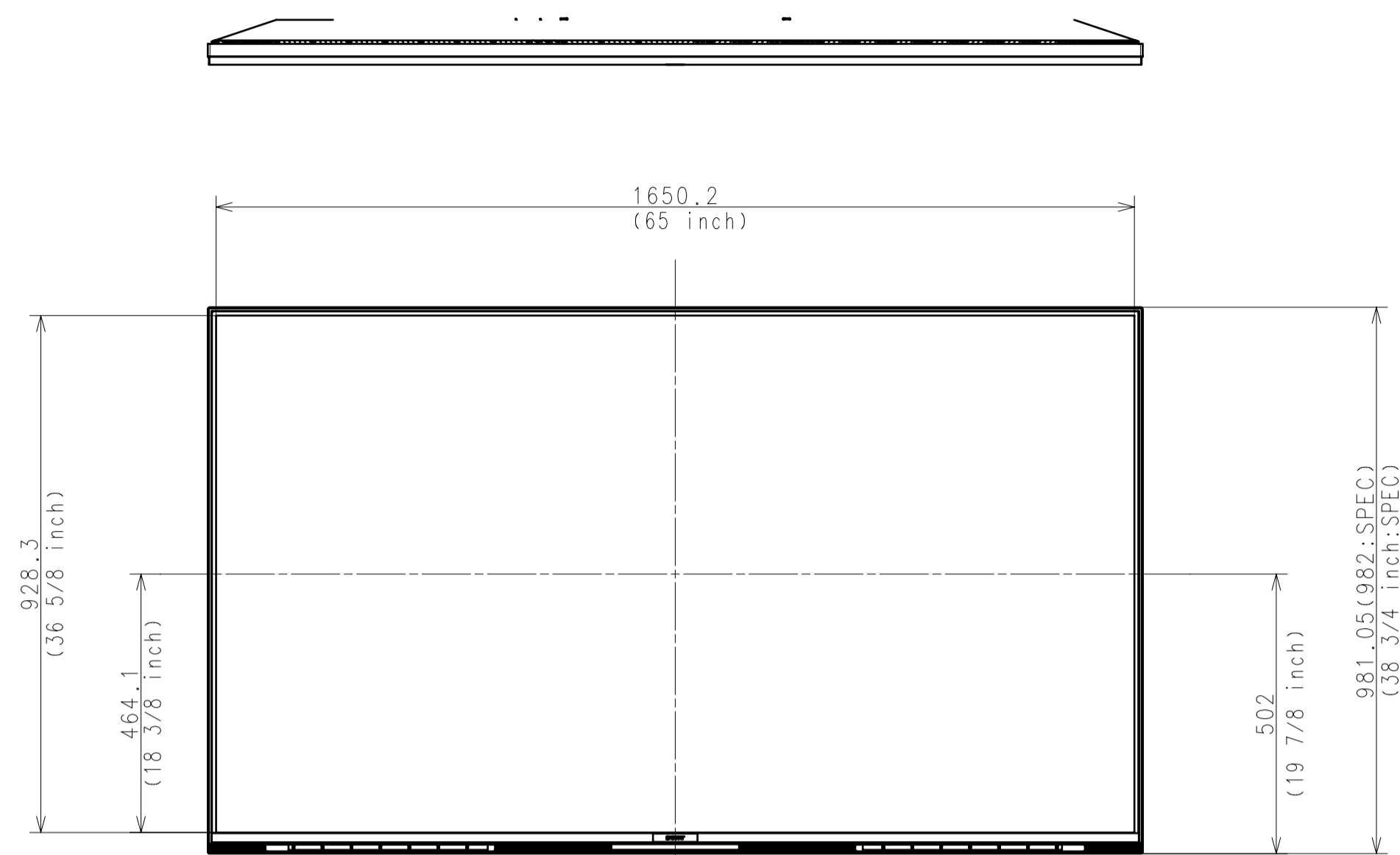

SU-WL450

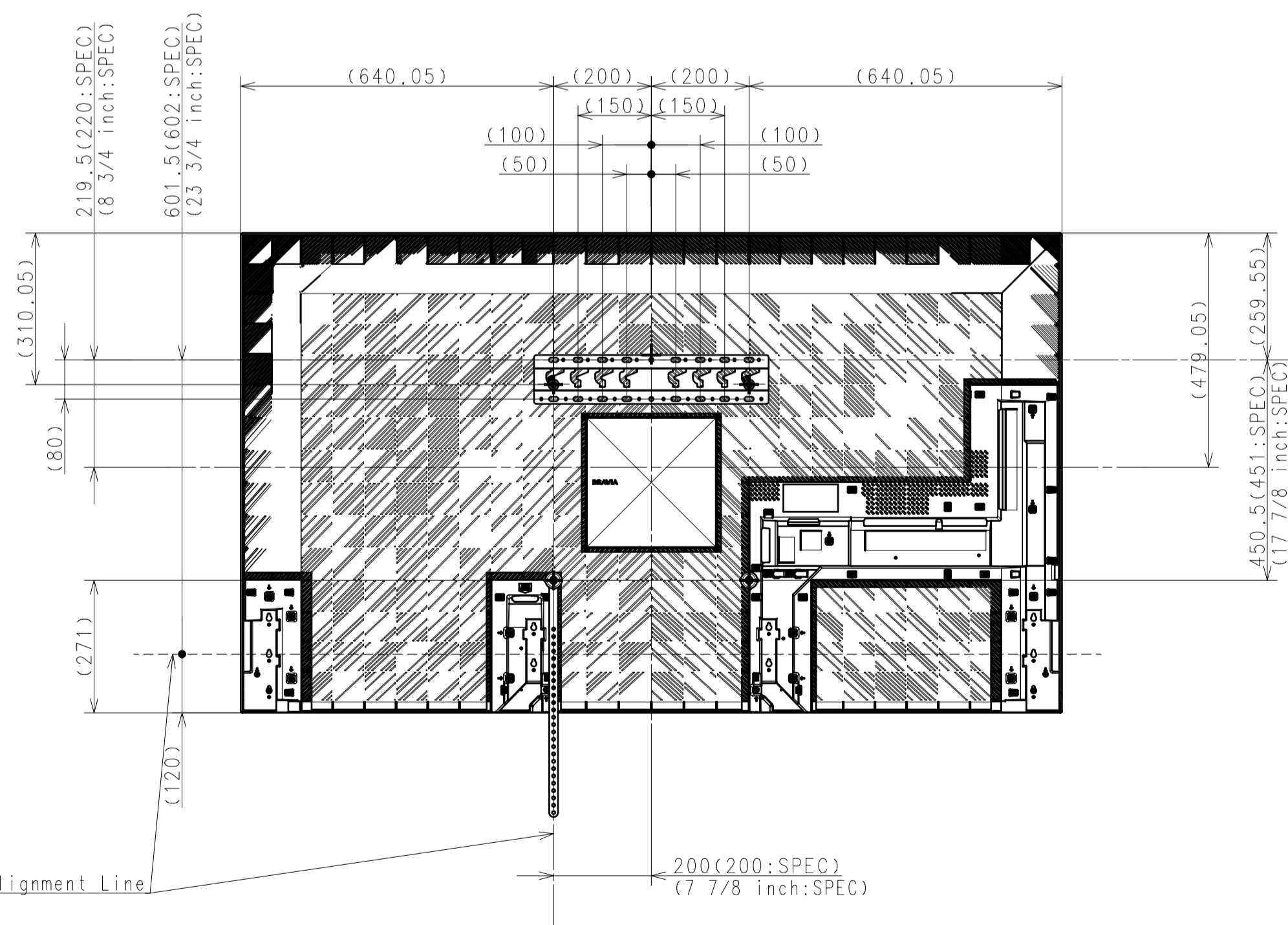

SLIM MOUNT

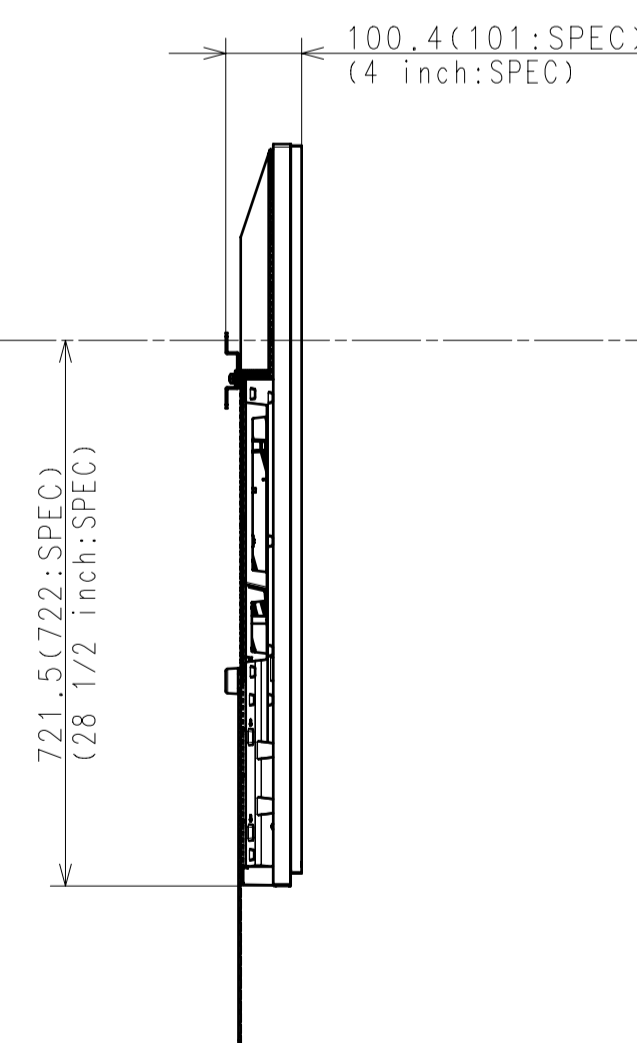

STANDARD MOUNT

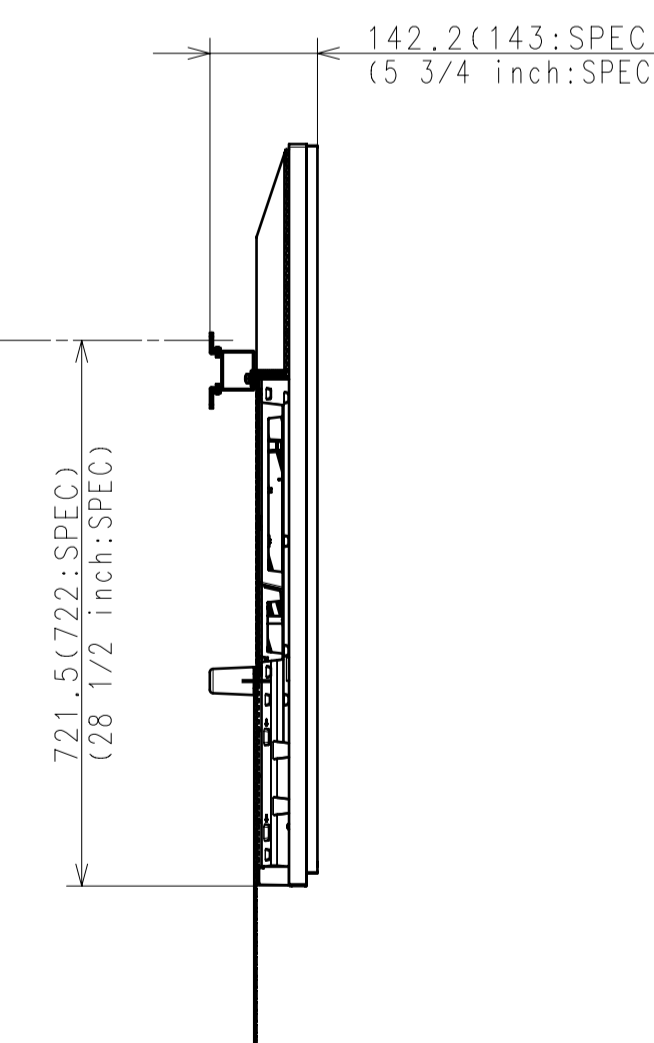

DESCRIPTION1 75(Z9J) EXTERIOR VIEW	LEGAL OWNER Sony Corporation	SCALE 1:10
DESCRIPTION2 75(Z9J) EXTERIOR VIEW	PART NO.	SHEET/PAGES 3 / 3