

Area		JAPAN	NORTH AMERICA	EUROPE	GENERAL AREA
Model Name		XRJ-48A90K	XR-48A90K	XR-48A90K	XR-48A90K
SV No.		SV-40372	SV-40222	SV-40344	SV-40276
DIMENSION	TV only (W x H x D)	106.9 x 62.4 x 5.9 (2.48) cm Δ	1069 x 624 x 59 (24.8) mm / 42 1/8 x 24 5/8 x 2 3/8 (1) inch Δ	Approx. 106.9 x 62.4 x 5.9 (2.48) cm Δ	Approx. 1069 x 624 x 59 (24.8) mm Δ
	TV only with camera (WxHxD)	-	-	-	-
	TV with Stand (Standard position) (W x H x D)	106.9 x 62.9 x 22.5 cm	1069 x 629 x 225 mm / 42 1/8 x 24 7/8 x 8 7/8 inch	Approx. 106.9 x 62.9 x 22.5 cm	Approx. 1069 x 629 x 225 mm
	TV with Stand (Narrow position) (W x H x D)	-	-	-	-
	TV with Stand (Soundbar position) (W x H x D)	106.9 x 69.7 x 22.5 cm	1069 x 697 x 225 mm / 42 1/8 x 27 1/2 x 8 7/8 inch	Approx. 106.9 x 69.7 x 22.5 cm	Approx. 1069 x 697 x 225 mm
	TV with Stand (Front position style) (W x H x D)	-	-	-	-
	TV with Stand (Back position style) (W x H x D)	-	-	-	-
	TV with Floor Stand (W x H x D)	-	-	-	-
	Stand Width (Standard position)	50.0 cm	500 mm / 19 3/4 inch	Approx. 50.0 cm	Approx. 500 mm
	Stand Width (Narrow position)	-	-	-	-
	Stand Width (Soundbar position)	50.0 cm	500 mm / 19 3/4 inch	Approx. 50.0 cm	Approx. 500 mm
	Stand Width (Front position style)	-	-	-	-
	Stand Width (Back position style)	-	-	-	-
	Floor Stand Width	-	-	-	-
VESA Hole Pitch	30.0 x 30.0 cm	300 x 300 mm / 11 7/8 x 11 7/8 inch	30.0 x 30.0 cm	300 x 300 mm	
WEIGHT	TV Only	13.4 kg	13.4 kg / 29.6 lb	Approx. 13.4 kg	Approx. 13.4 kg
	TV with Stand (Standard position)	16.5 kg	16.5 kg / 36.4 lb	Approx. 16.5 kg	Approx. 16.5 kg
	TV with Stand (Narrow position)	-	-	-	-
	TV with Stand (Soundbar position)	16.8 kg	16.8 kg / 37.1 lb	Approx. 16.8 kg	Approx. 16.8 kg
	TV with Stand (Front/Back position style)	-	-	-	-
	TV with Floor Stand	-	-	-	-
	Floor Stand weight (Supply)	-	-	-	-
	W-M't Br. Weight (Supply)	-	-	-	-
Remarks		2way	2way	2way	2way

WITH STAND
STANDARD POSITION STYLE

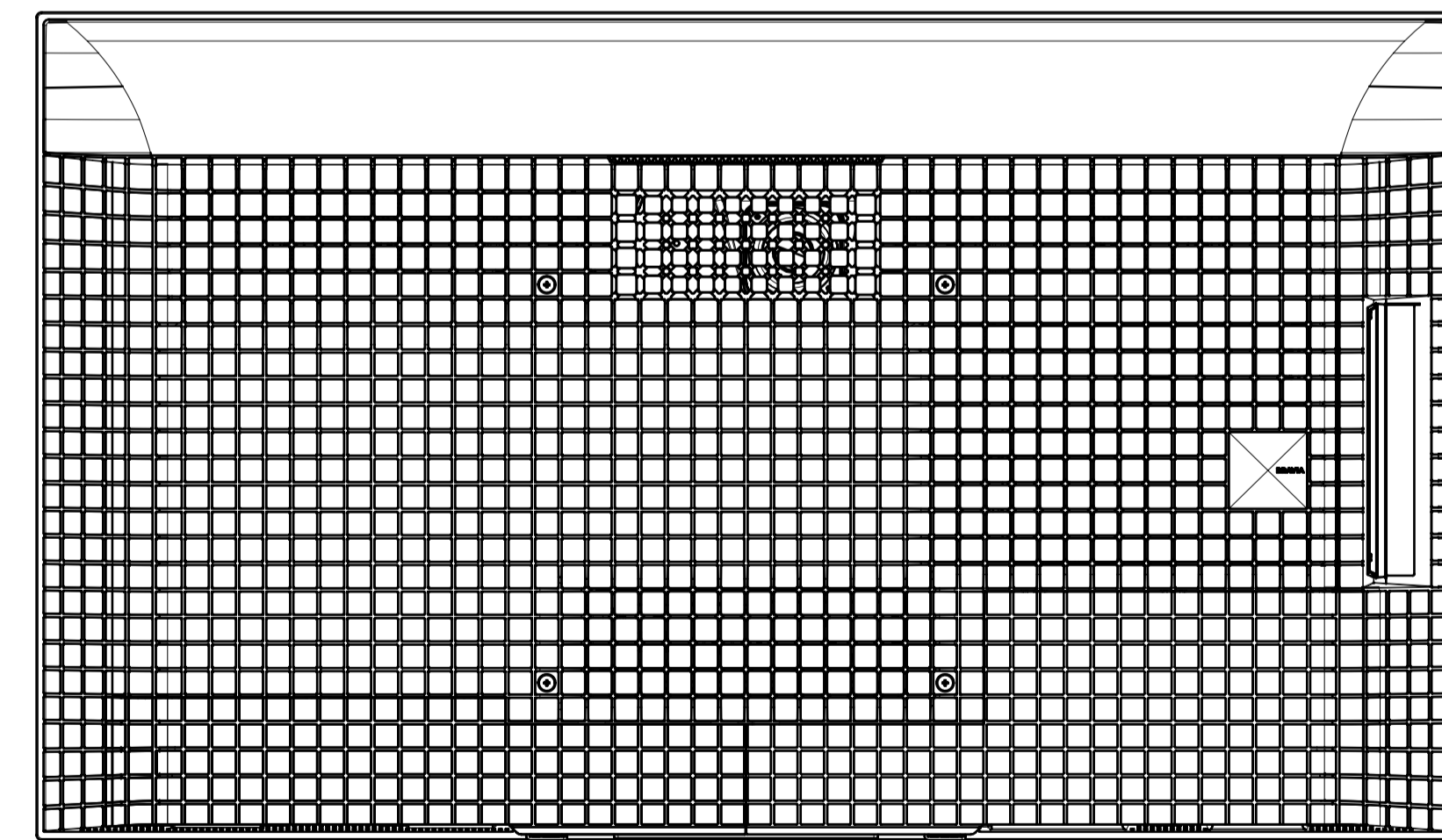
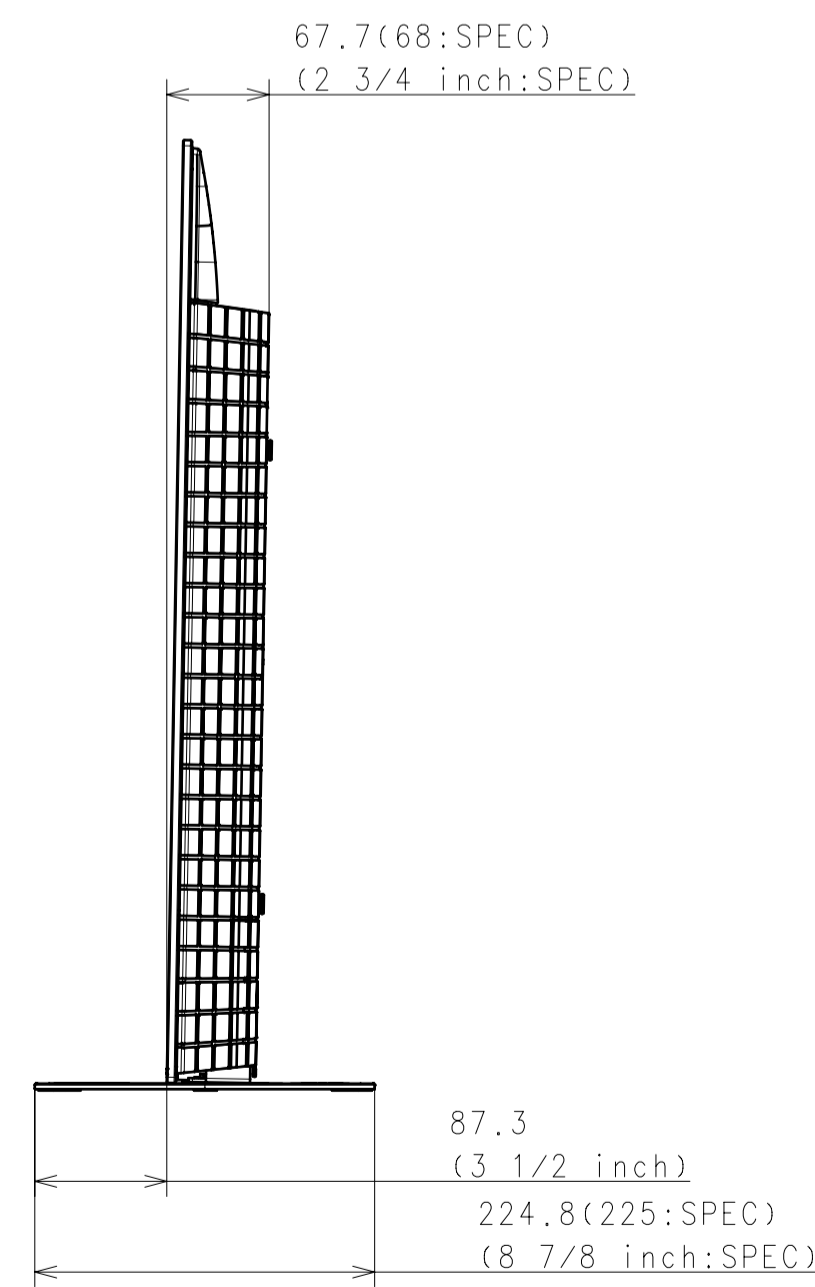
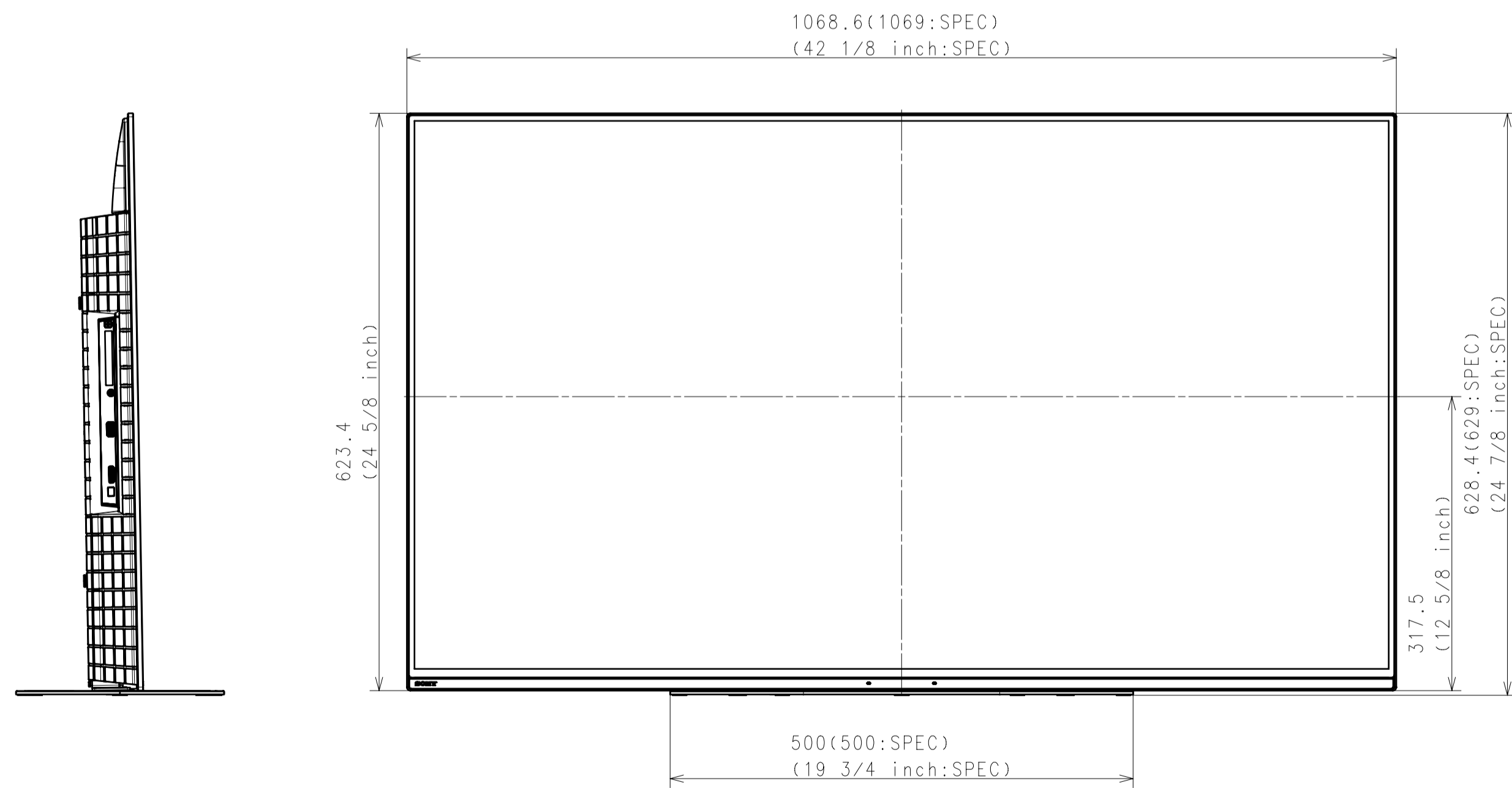
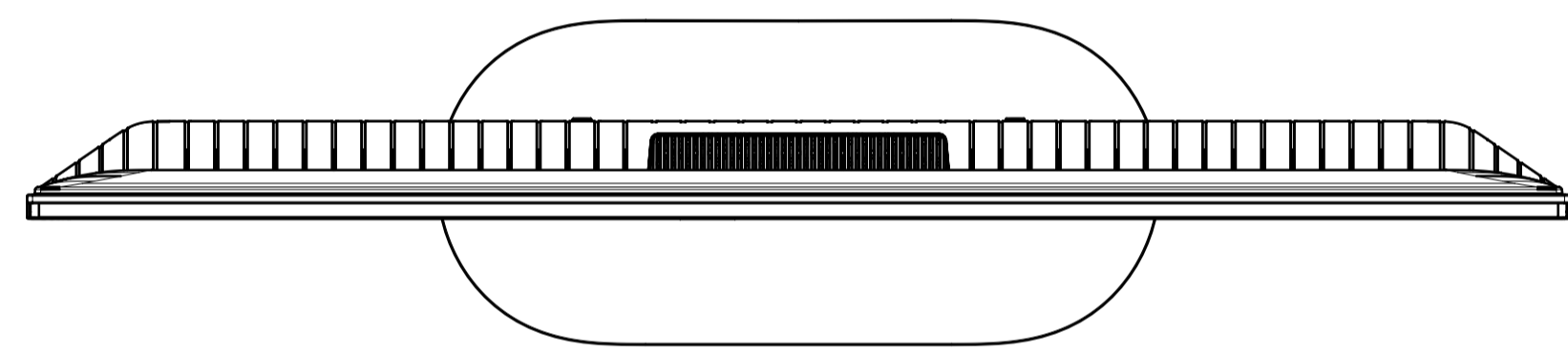

Purchase recycled resins and wire rods only from the business partners that Sony approves as Green Partners.
再生樹脂・鋼線鋼材はグリーンパートナー 認定受注先から調達すること。

△x						GENERAL TOLERANCE	DATE OF ISSUE
△y							2021.12.22
△z	5	2022.03.07	REVISE TABLE & DIMENSION	ILWMAN			DOCUMENT TYPE
HISTORY	SUFFIX	RELEASE NO.	REVISION	SIGN.			PART
X COUNT	PREL. NO.	DATE					DRAWING
							(JIS & ISO/IEC JIS)
LEGAL OWNER						MATERIAL COLOR	FINISH COLOR
Sony Corporation							
RESPONSIBLE DEPARTMENT	PLANNED BY	DESIGNED BY	APPROVED BY	SCALE	TENTATIVE MODEL	ORIGINAL MODEL	DESCRIPTION
Panel & Mechanical Design	2021.12.22	ILWMAN		1:5			48(A90K) EXTERIOR VIEW
DRAWN BY				SIZE	UNIT	PART NO.	SUFFIX
2021.12.22				A1	mm		REV. NO.
ILWMAN							1/4
<small>THIS DRAWING IS THE PROPERTY OF SONY CORPORATION. IT IS TO BE USED ONLY FOR THE PURPOSES SPECIFIED IN THE ORDER. IT IS NOT TO BE REPRODUCED OR TRANSMITTED IN ANY FORM OR BY ANY MEANS, ELECTRONIC OR MECHANICAL, INCLUDING PHOTOCOPYING, RECORDING, OR BY ANY INFORMATION STORAGE AND RETRIEVAL SYSTEM, WITHOUT THE WRITTEN PERMISSION OF SONY CORPORATION. THE COMPANY SHALL NOT BE RESPONSIBLE FOR ANY DAMAGES OR LOSSES ARISING FROM THE USE OF THIS DRAWING.</small>							

WITH STAND
SOUNDBAR POSITION STYLE

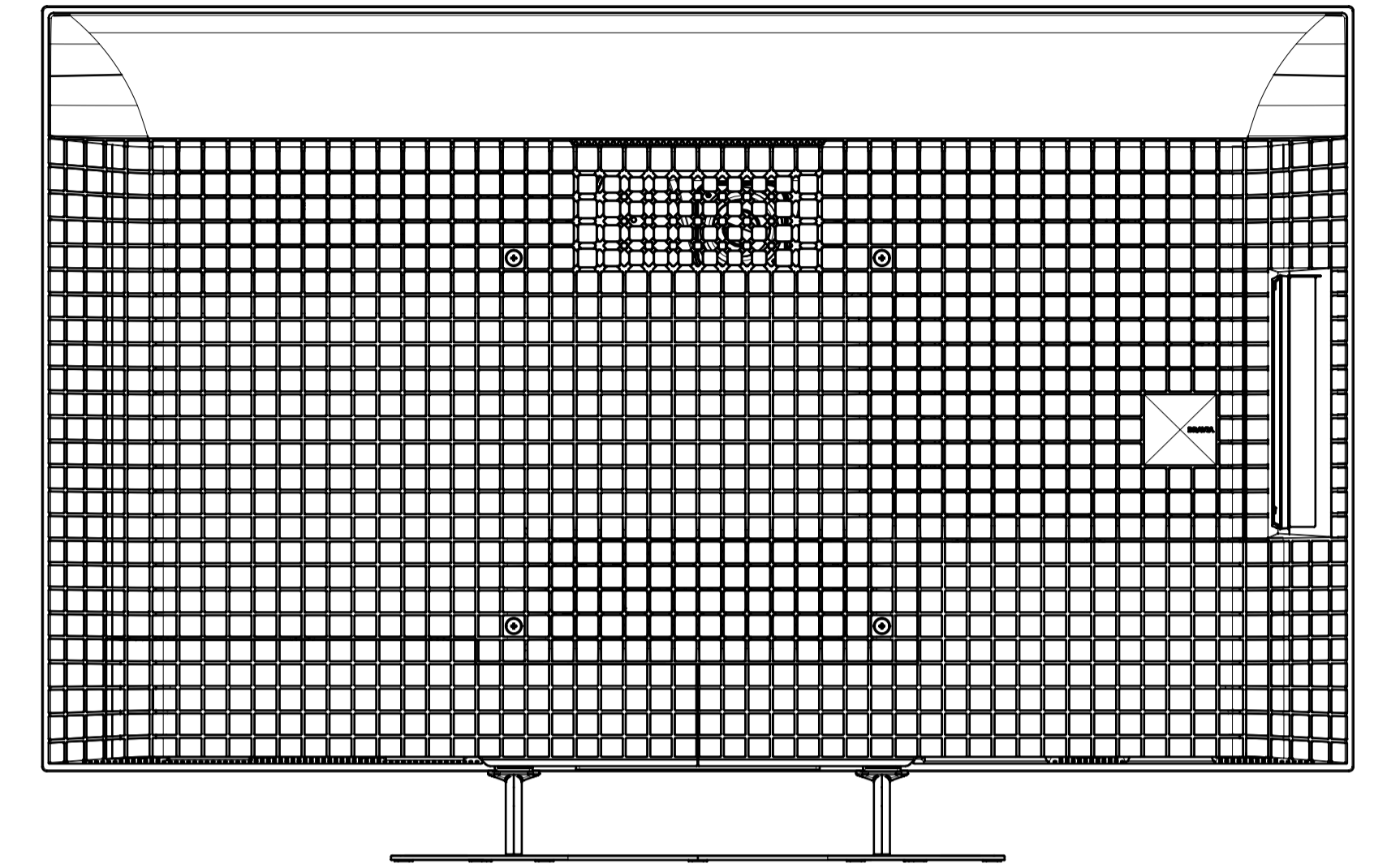
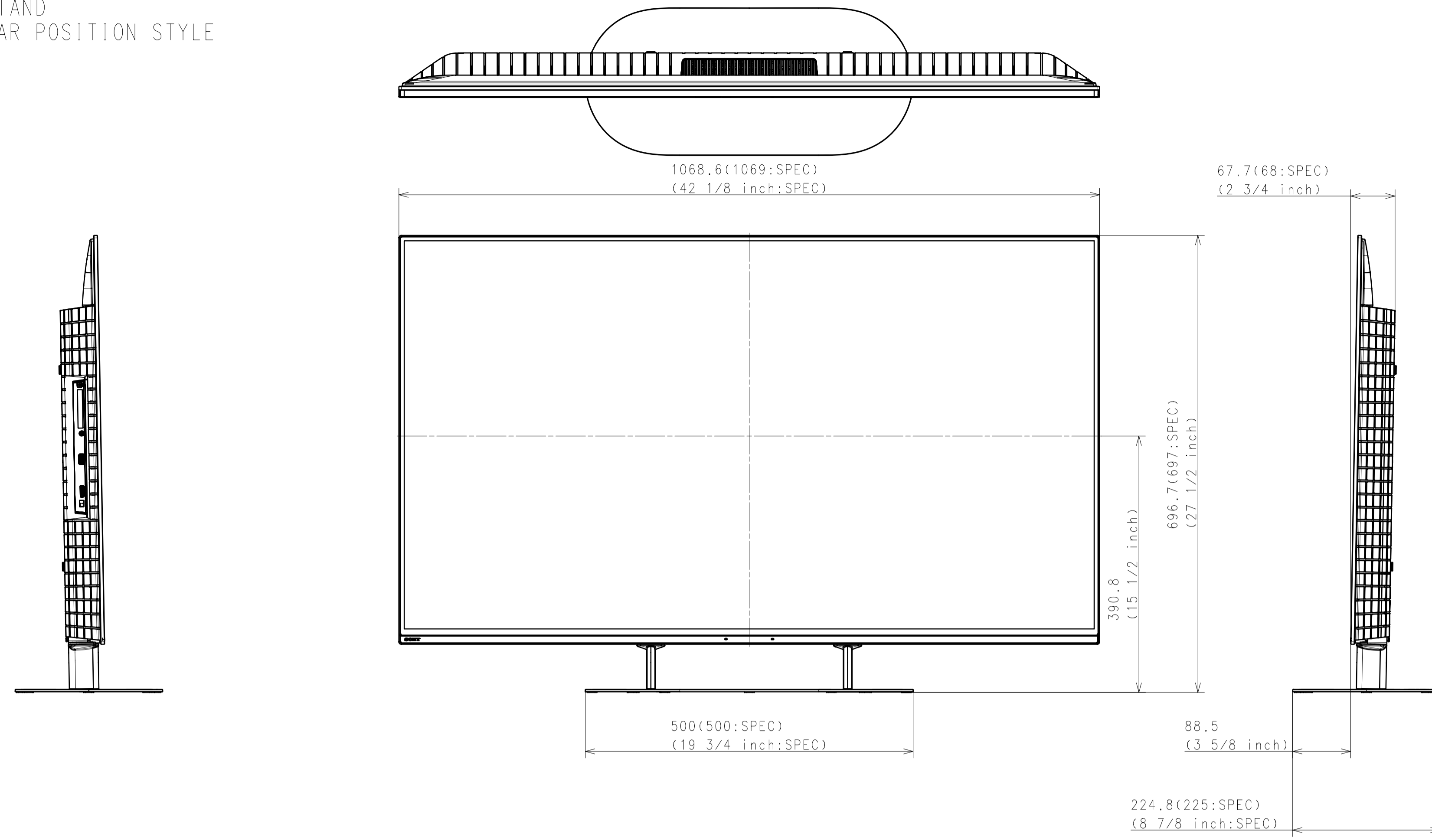

WITHOUT STAND

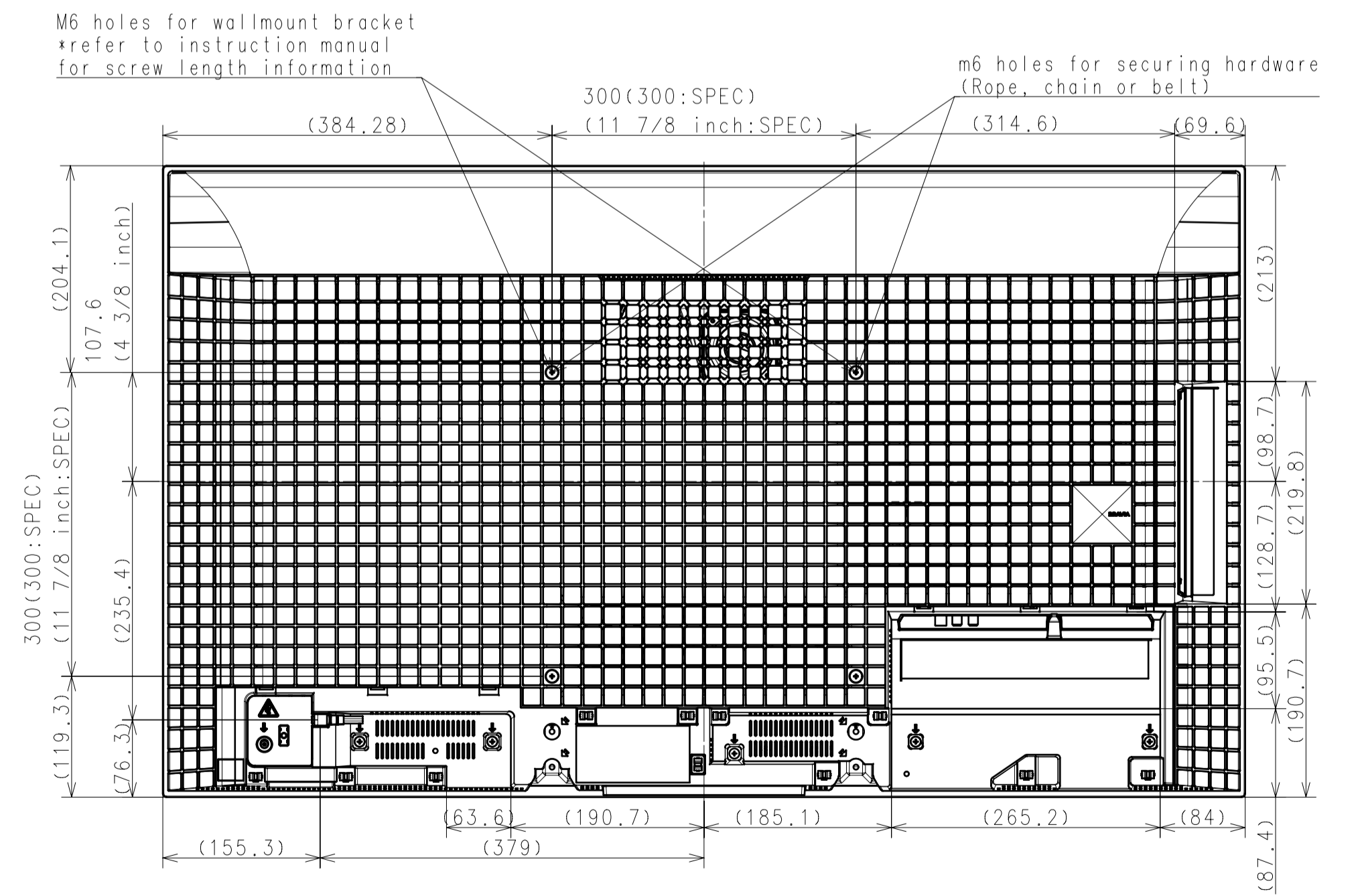
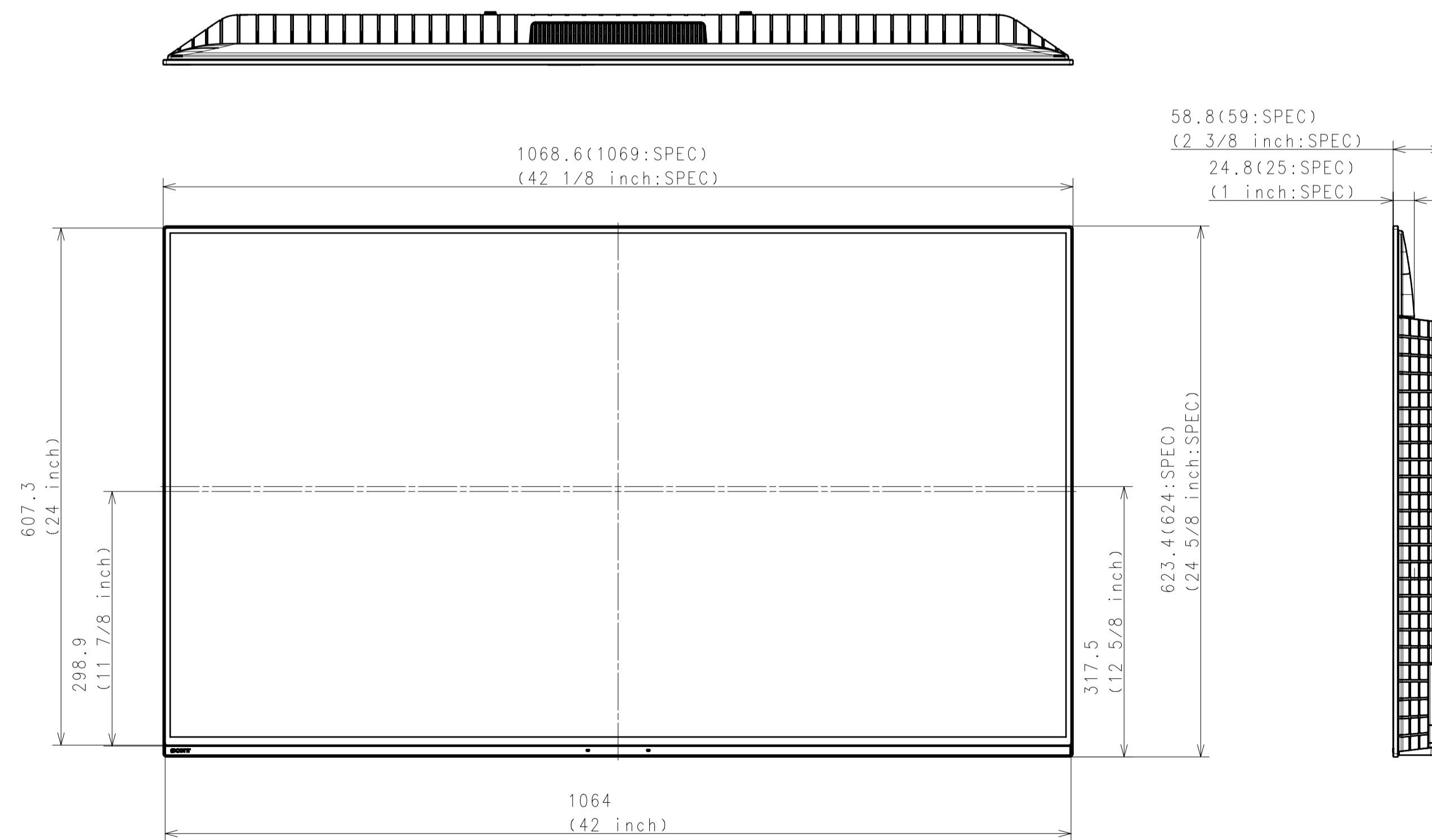

SU-WL450 SLIM

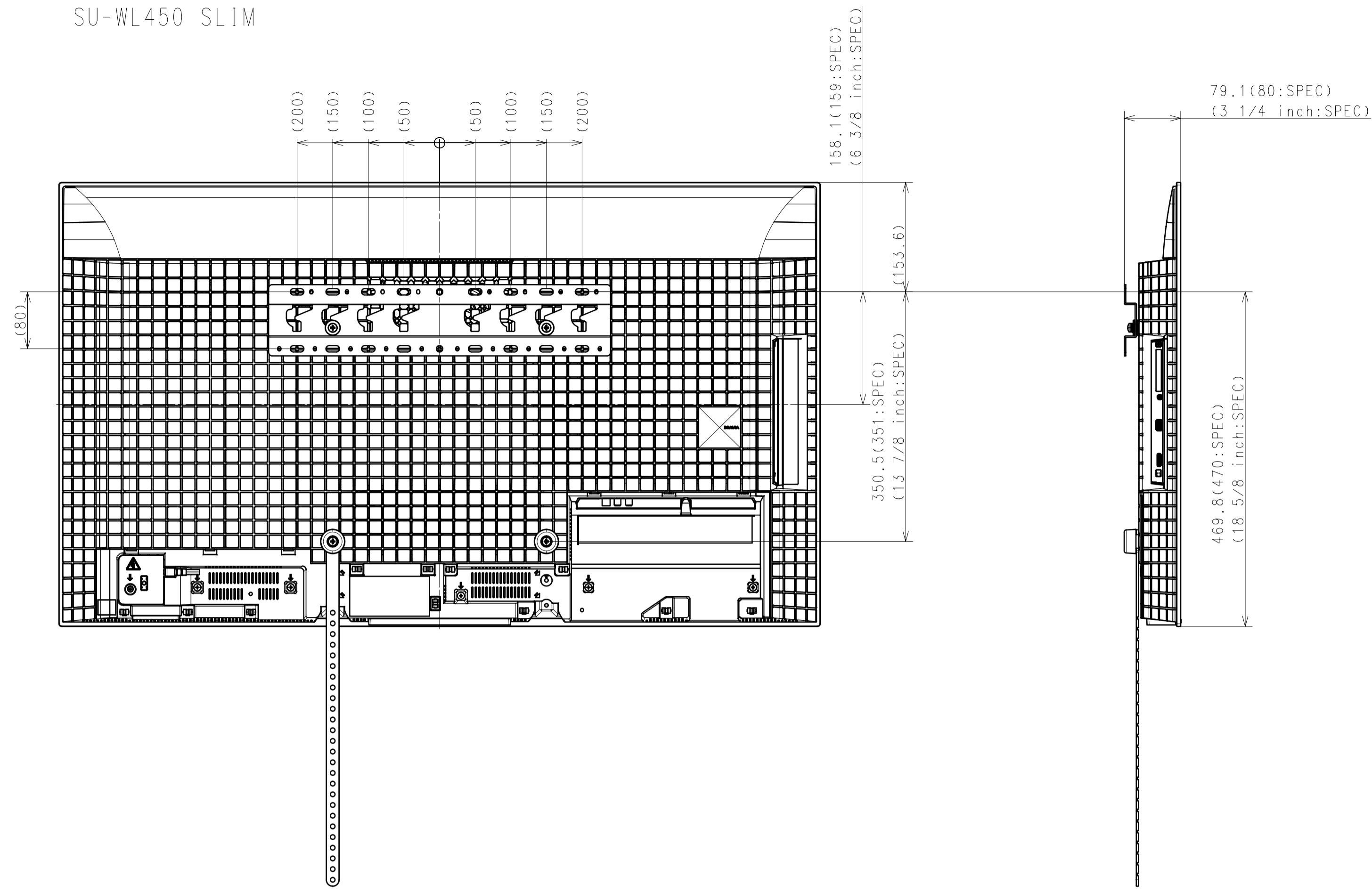

SU-WL450 STANDARD

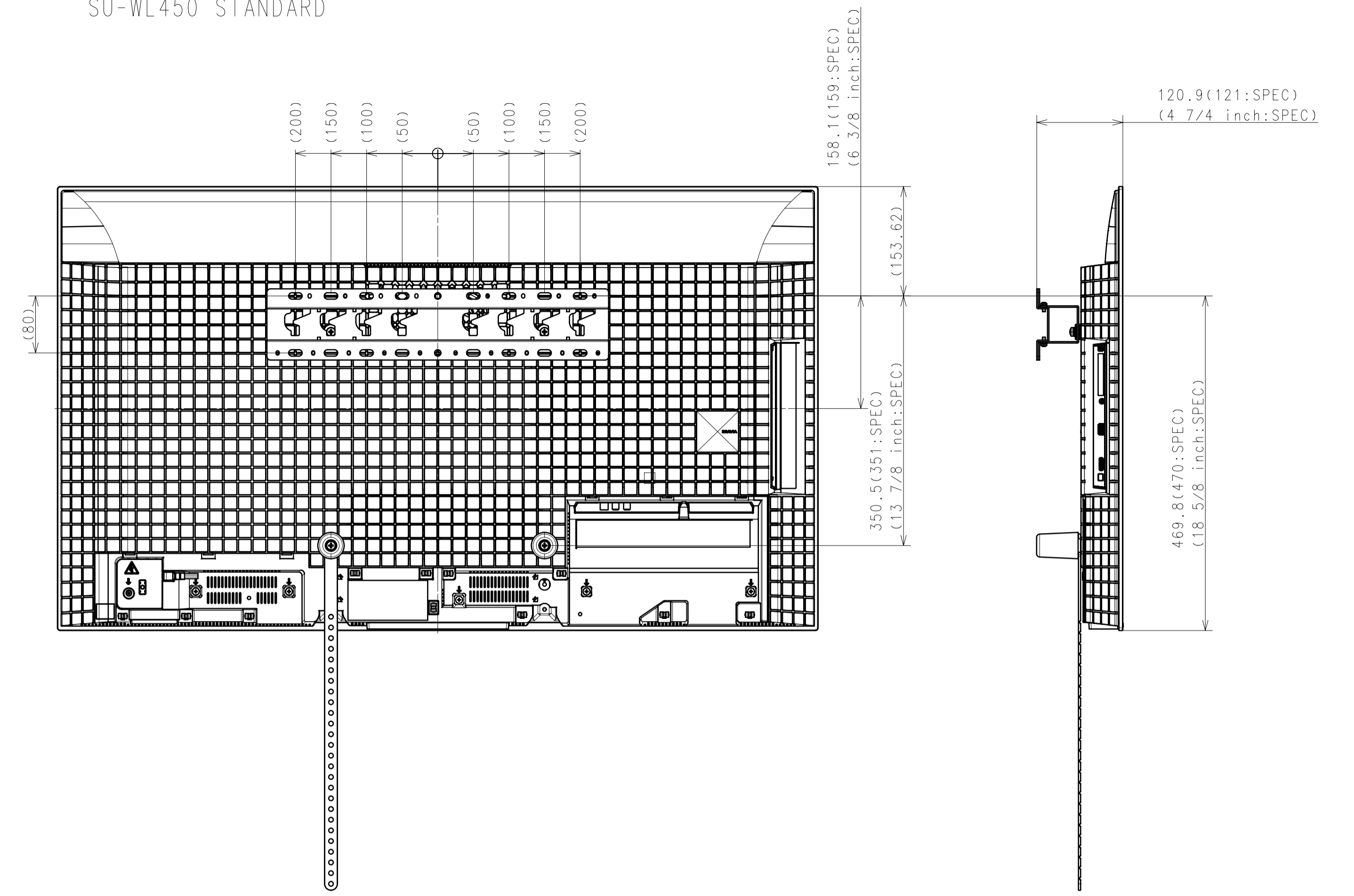

SU WL-850

SU WL-855 WITH LATERAL SHAFT BRACKET

