



SONY

CINEMA IS COMING HOME

Home Cinema Projector 2024

Sony introduces  
"Pro Cinematic HDR" experience



**BRAVIA Projector 8**

VPL-XW6100ES

Bring the authentic big screen home

NEW



XR Dynamic Tone Mapping



XR Deep Black



XR Triluminos Pro



XR Clear Image



## BRAVIA Projector 8

VPL-XW6100ES

Laser with ACF-Lens | 4K HDR | 2,700 lm

Bring every movie to life at home on the big screen powered by our XR Processor for projector and our class-leading laser light source. Enjoy precision and clarity with rich gradation, deep blacks, and brilliant colors.

Bring home entertainment with  
a native 4K, high-value laser projector



Color : Black/White

**Z-Phosphor**  
LASER LIGHT SOURCE

**X1**  
Ultimate  
for projector

 **Triluminos Pro**

Ultimate 4K SXRD™ 10,000lm  
Laser Projector



**Z-Phosphor**  
LASER LIGHT SOURCE

**X1**  
Ultimate  
for projector

 **Triluminos Pro**

### VPL-XW5000ES

Laser | 4K HDR | 2,000 lm

Bring the action home with up to 2,000 lumens of high brightness, generated by a long-lasting laser light source, for vibrant images even on a large screen.



### VPL-GTZ380

ARC-F Lens\* | 4K HDR | 10,000 lm

The Sony VPL-GTZ380 is the world's most advanced projector designed for large home cinemas to bring a true theater experience home. An exceptional 10,000 lumens of brightness with 100% DCI-P3 wide color gamut is perfect for the largest and most lavishly equipped home cinema rooms.

\*The ARC-F lens is optional.

## Sony Home Cinema Projector Lineup

	4K HDR LASER PHOSPHOR PROJECTOR		
	 <b>NEW</b>	 Color : Black/White	
Model	<b>BRAVIA Projector 8</b> VPL-XW6100ES	VPL-XW5000ES	VPL-GTZ380
Brightness	2,700 lm	2,000 lm	10,000 lm
Picture Engine	XR Processor for projector	X1 Ultimate for projector	X1 Ultimate for projector
Light Source Enhancer	Laser	Laser	Laser
Resolution	Native 4K	Native 4K	Native 4K
Lens (Bundled)	ACF-Lens	Standard 4K Lens	-
Dynamic Contrast	∞:1	∞:1	∞:1
Color space	95% DCI-P3 XR Triluminos Pro	95% DCI-P3 Triluminos Pro	100% DCI-P3 Triluminos Pro
Screen Adjustment	Picture Position + Keystone	-	Picture Position
Accessories Lens (Optional)	-	-	VPLL-Z8014 (Standard ARC-F) VPLL-Z8008 (Short throw)

# Picture Quality

High brightness technology with  
XR Processor for projector



Bring every movie to new life with the ultimate home cinema experience powered by our XR Processor for projector and our class-leading laser light source. Enjoy precision and clarity with rich gradation, deep blacks, and brilliant colors.

# XR Processor for Projector

## XR Dynamic Tone Mapping

XR Dynamic Tone Mapping optimizes brightness frame by frame, ensuring perfect gradation and contrast while keeping creator's intent.

\*BRAVIA Projector 8 only

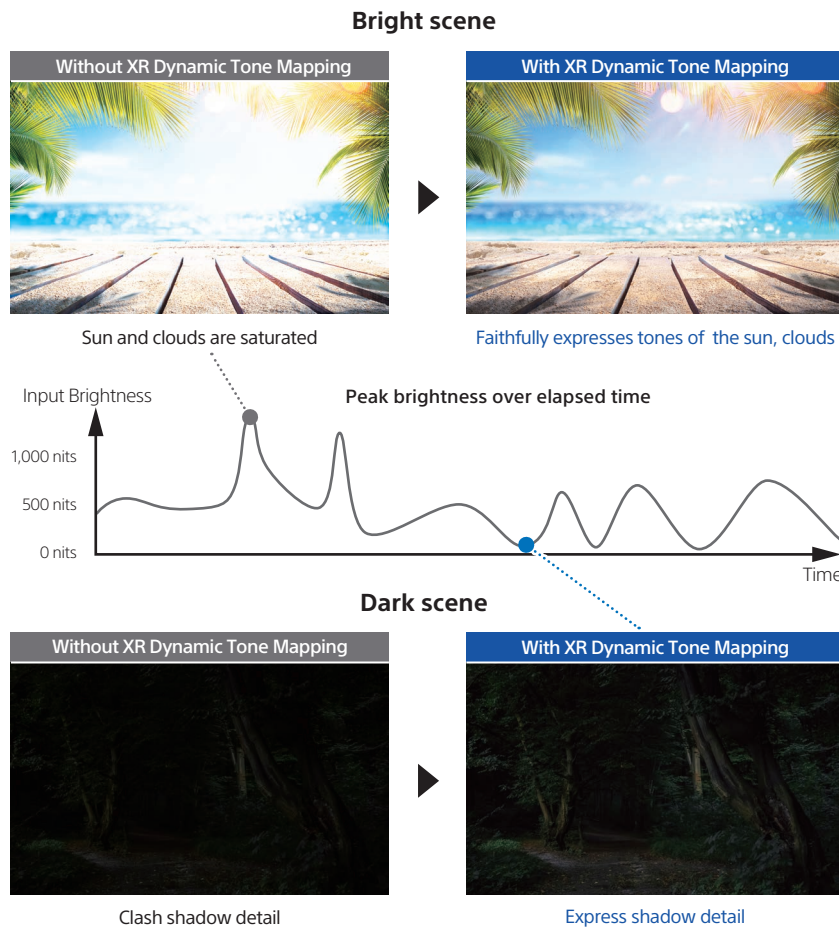

## XR Deep Black

XR Deep Black technology enhances dark scenes with deeper blacks and precise color expression by controlling laser dimming in dark scenes and optimizing highlight processing.

\*BRAVIA Projector 8 only

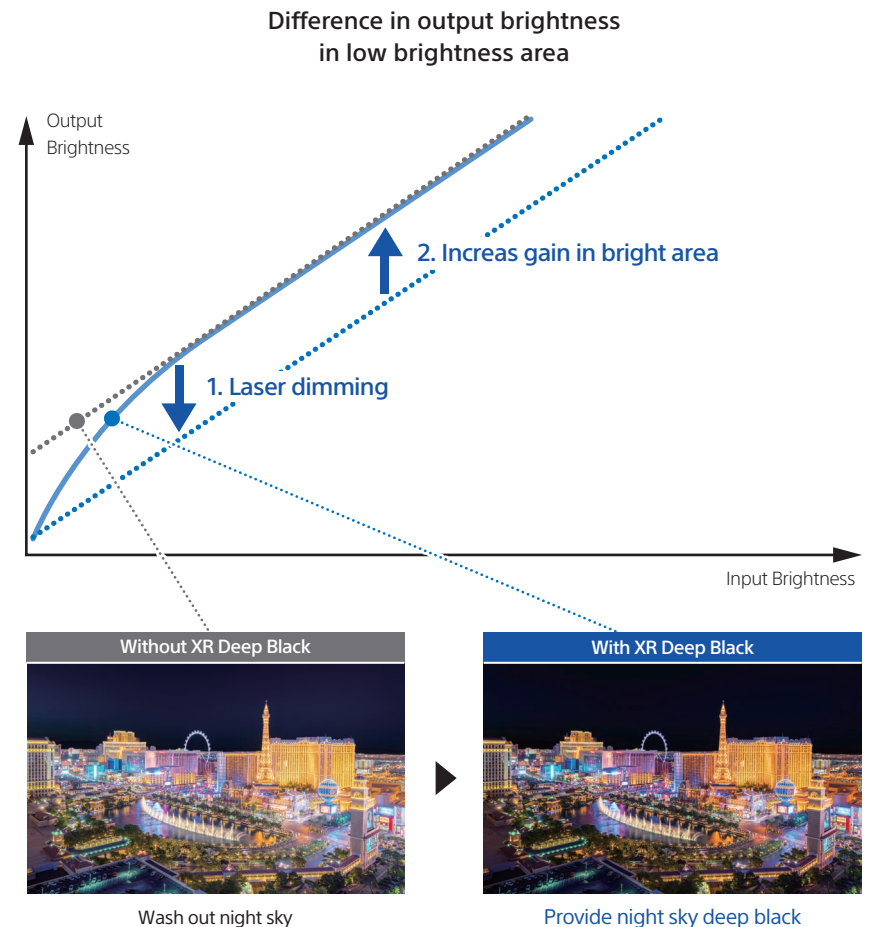

## XR Triluminos Pro

XR Triluminos Pro brings over a billion colors to life.

\*BRAVIA Projector 8 only

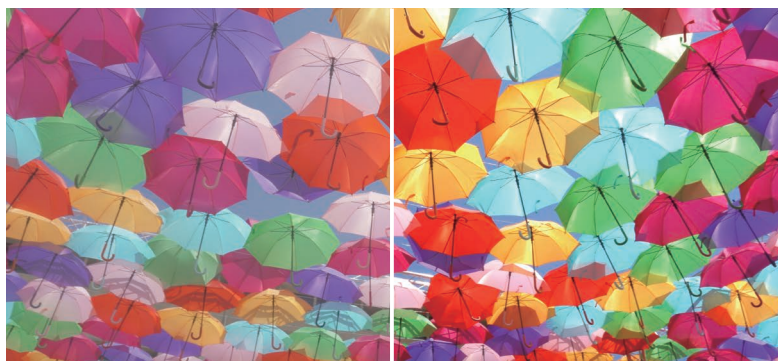

Without XR Triluminos Pro

With XR Triluminos Pro

## Wide color gamut and High brightness

This combined with high brightness and expanded color volume delivers outstanding color expression.

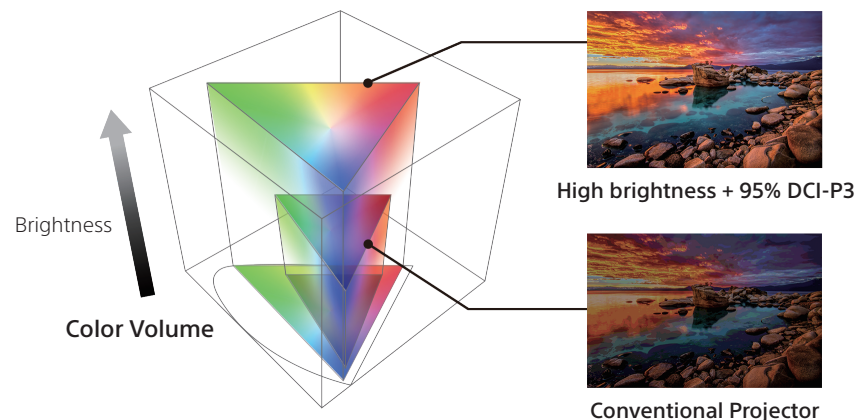

High brightness + 95% DCI-P3

Conventional Projector

## XR Clear Image

XR Clear Image analyzes individual object frame-by-frame and expresses textures close to reality down to the finest detail while minimizing noise.

\*BRAVIA Projector 8 only

### Best Clarity for individual objects

Focus on the finest details. XR technology hones in on individual details, bringing unparalleled sharpness and precision to every scene.

Without XR Clear image    With XR Clear image

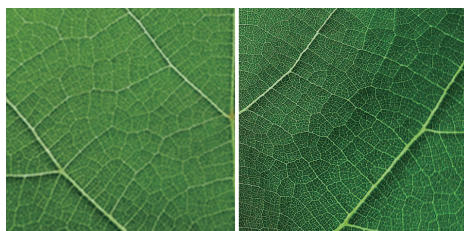

### Everything upscaled to 4K quality

See everything in crisp 4K quality. XR upscaling technology smartly recreates lost textures and details, transforming every frame to restore the director's vision.

Without XR Clear image    With XR Clear image

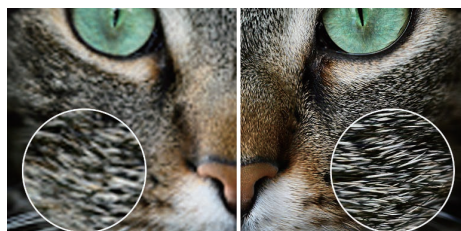

### Beautiful images without noise

Uncompromised clarity. XR's noise reduction technology ensures smooth, distraction-free visuals.

Without XR Clear image    With XR Clear image

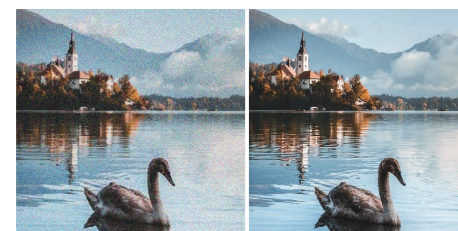



# Background technologies to achieve value

XR Processor for projector optimizes our acclaimed BRAVIA TV video processing for projection.

## Cross-Analyzes

Rather than processing various elements such as color, definition, and contrast individually, it analyzes them cross-sectionally to provide more natural-looking images without artificial impressions.

\*BRAVIA Projector 8 only

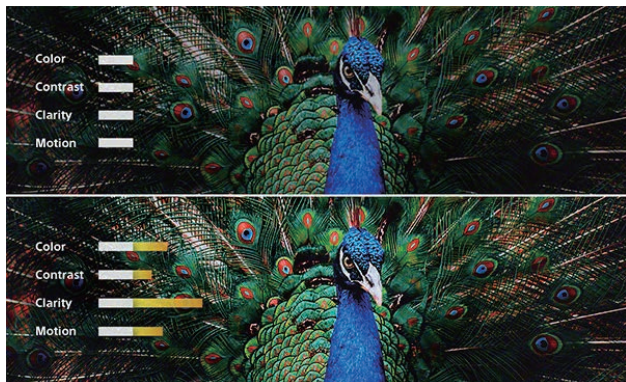

## Depth Mapping

It utilizes Human Cognitive technology to enhance depth and texture for immersive experiences. Foreground depth is enhanced and the background adjusted so the entire image looks more real and natural.

\*BRAVIA Projector 8 only

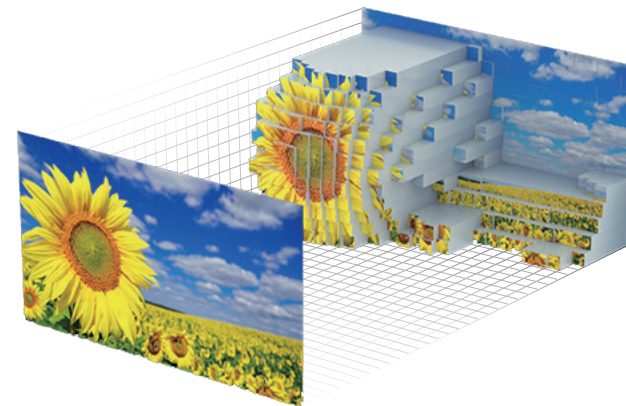

## Focal Points recognition

The focal point is where you tend to focus in a picture, where your eyes are naturally drawn to within the scene. It recognizes that focal point and enhances that part of the image.

\*BRAVIA Projector 8 only





# Installation Flexibility

Effortless installation.

Endless possibilities.

With effortless installation, Sony projectors open up endless possibilities.

The compact, lightweight design allows for versatile setup in any space.

## Compact and lightweight

Say goodbye to heavy lifting. Weighing in at 14kg, our projectors pack a punch without the bulk.



**BRAVIA Projector 8**



**VPL-XW5000ES**

## Flexible installation, consistent clarity

Effortlessly adjust your image for geometry, ensuring seamless projection at any ceiling or stand height by using with the lens shift function and corner keystone correction in combination. With XR Clear Image, content can be projected while maintaining as much clarity as possible.

\*BRAVIA Projector 8 only

**Without Corner keystone correction**



Projected as a trapezoid

**With Corner keystone correction**



Can be adjusted to shape to fit the screen

## Default picture setting ideal for cinema

Stunning visuals right out of the box. Sony Home Cinema Projectors are pre-configured for cinematic color and gamma, with extensive adjustment and calibration options available if needed.

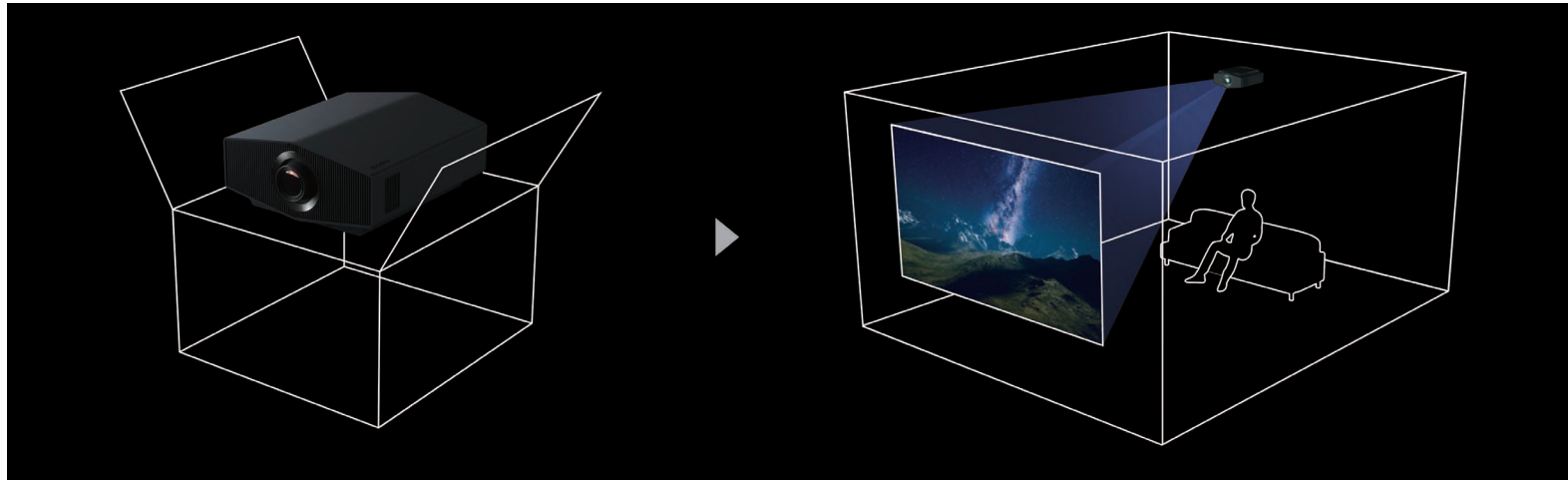

## Precision controls for perfect viewing

Explore countless ways to enhance your home cinema experience with customisable settings for color correction, color space, and gamma correction to display images just the way you like them.

### Color correction

Precise color correction technology enhances the accuracy of every hue, creating lifelike images with rich tones.

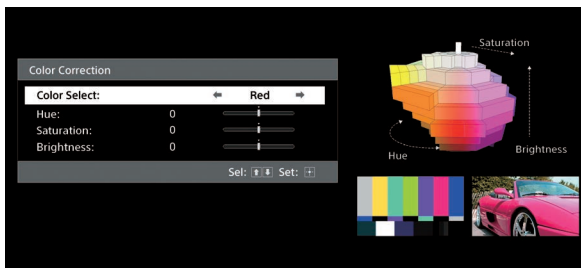

### Color space

With a huge 95% DCI-P3 color gamut, and custom color space tuning, all your visuals are more immersive and realistic.

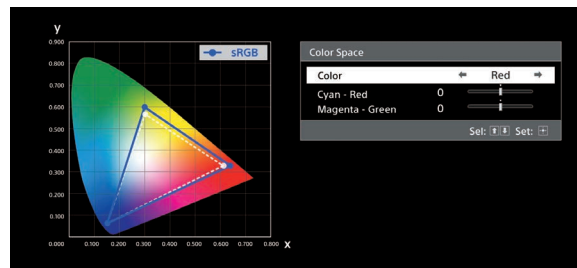

### Gamma correction

It configures the response characteristics of gradation of the corrected image.

\*BRAVIA Projector 8 only

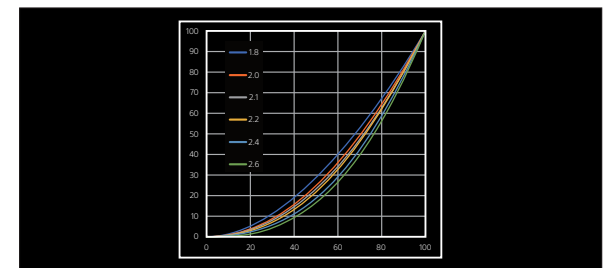

# Usability

Reliability meet usability



Built for reliability and designed for usability, our projectors integrate seamlessly with industry protocols and major solutions.

# Reliable operation with standard industry protocols as well as major solution partners

## Home Automation Systems

---

One remote to manage it all. Easily integrate your projector with top home automation systems like Control4, Crestron, Savant, AMX.

Control4

WORKS WITH  
CRESTRON HOME

SAVANT

AMX  
by HARMAN

## Remote diagnostics

---

Ideal for advanced custom installations, Sony home cinema projectors support remote monitoring and diagnostics of network settings, status, and even temperature.



ovrc

demotz

# With 4K/120fps and ALLM (Auto Low Latency Mode) by HDMI2.1, it gives smooth and clear movement for responsive gameplay.

## 4K/120 fps\*1

Experience lightning-fast, smooth visuals in 4K at 120 frames per second. Perfect for action-packed gaming.

\*BRAVIA Projector 8 only

## 4K/60 fps

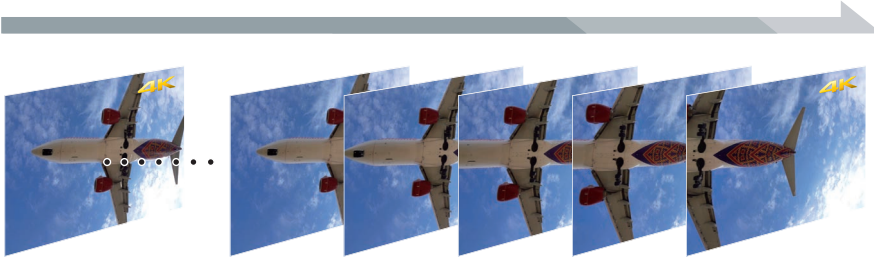

## 4K/120 fps

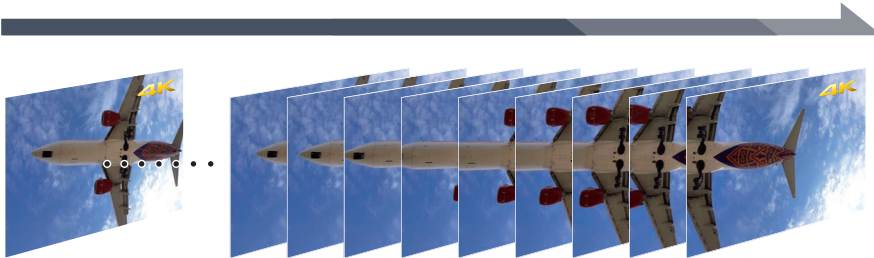

\*1: 4K/120fps compatible games

## Auto Low Latency Mode\*2

Always game-ready. Automatically switch to game mode with Auto Low Latency Mode, ensuring responsive play and minimal lag.

\*BRAVIA Projector 8 only



Auto Low Latency Mode: OFF



Auto Low Latency Mode: ON

BRAVIA Projector 8

Input lag reduction

21 msec for 4K/60 fps signal

12 msec for 4K/120 fps signal

\*2: The Projector automatically switches Input Lag Reduction mode to on based on the ALLM information from the HDMI-connected device. In this mode, Motionflow and NR cannot be used.



# Sustainability

Better tech. Better planet

Better tech helps maintain a better planet.

Our projectors are designed with sustainability in mind, featuring mercury-free components and enhanced power efficiency.



# Environmentally friendly design

Better tech helps maintain a better planet. Our projectors are designed with sustainability in mind, featuring mercury-free components and enhanced power efficiency.

## Power efficiency

Maximize energy efficiency without compromising on picture quality, with XR Deep Black's advanced laser control technology. Save on power, not on quality.

Power consumption in the dark scene



Conventional model



With XR Deep Black



## Mercury-free

Safer and greener. Our projectors use mercury-free laser light sources, designed to be safer for the environment and your home.

Mercury usage

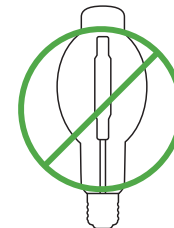

0%

All our projectors use mercury-free laser light sources.

## 4K Motionflow

The powerful video processor in the projector offers Motionflow for smooth and clear motion, even when viewing 4K content. Motionflow is ideal for fast-moving sports content, as it adds frames to reduce blur while maintaining brightness. Cinema purists can choose True Theatre mode to retain the original 24 fps.



Motionflow: **OFF**



Motionflow: **ON**

Simulated images

## Picture Position Memory

Store focus, zoom and lens-shift settings for up to five screen formats for easy recall. Picture Position Memories store key settings so you can quickly watch movies in the ideal format. Match aspect ratios, including 16:9 and Cinemascope, and store these settings in your 4K projector.

\*GTZ380 / BRAVIA Projector 8 only

## Anamorphic lens compatibility for 4K signals (V-stretch for 4K)

Wide lens compatibility means you can use your legacy anamorphic lenses with ease, even with 4K content. Watch your content in your favorite formats with a full-size picture, thanks to the V-stretch function.

## Make the home cinema experience bigger and better than ever

Sony 4K projectors are compatible with IMAX Enhanced content, making them ready to deliver the bigger, more breathtaking IMAX visuals you love in compatible content. Take advantage of the size of your projector screen with movies that become even more immersive with IMAX Enhanced.



**IMAX**<sup>®</sup>  
ENHANCED

## Native 4K SXRD™ panel.

Immerse yourself in an incredibly lifelike picture with native 4K that offers 8.3 million pixels (3,840 x 2,160). With an 0.61-inch SXRD panel, you'll enjoy high brightness, inky blacks, vibrant colors, rich tones and textures, plus clear cinematic motion and image smoothness.

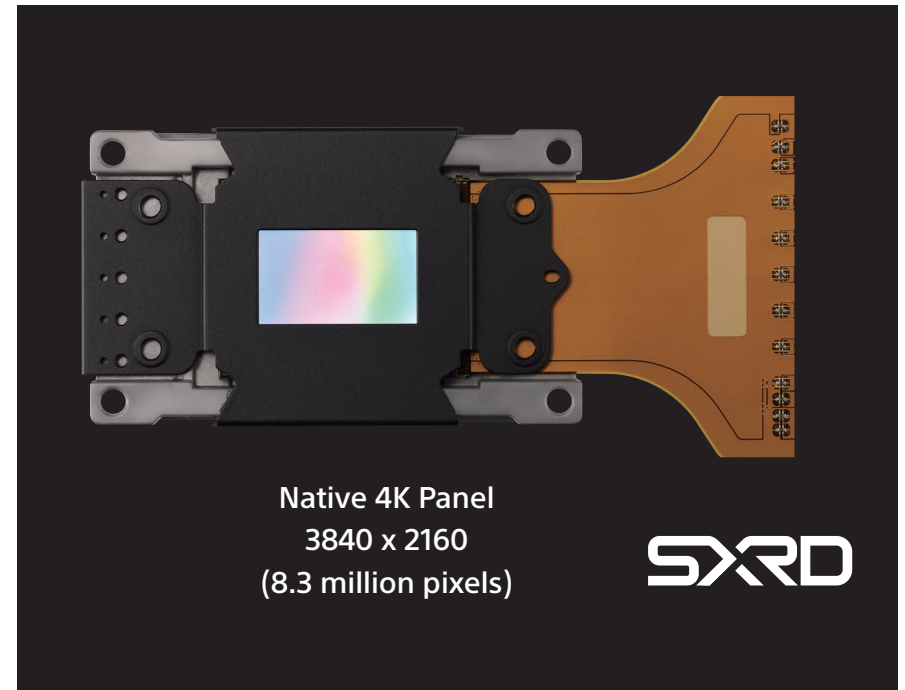

## Wide Dynamic Range Optics

Our Wide Dynamic Range Optics contribute to a compact design with better light control by maximising the potential of the laser light source.

The resulting higher color volume means naturally colorful images, even at high brightness levels, and stunning, immersive contrast.

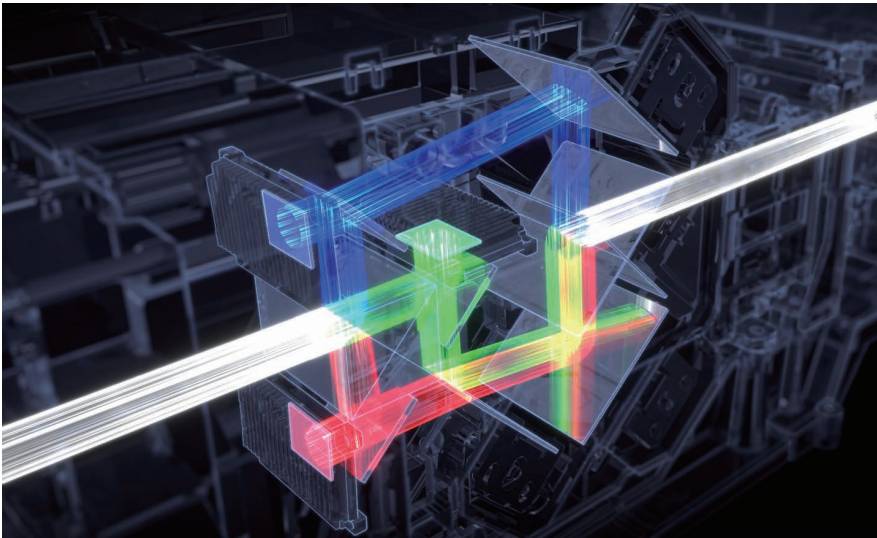

## Enduring brightness from a laser light source

You'll never have to worry about changing the lamp in your home cinema projector—no lamp replacement and virtually no maintenance are required.

The projector uses an ultra-pure and reliable laser light source, which lets you enjoy perfectly clear 4K pictures at optimal brightness for up to 20,000 uninterrupted hours.

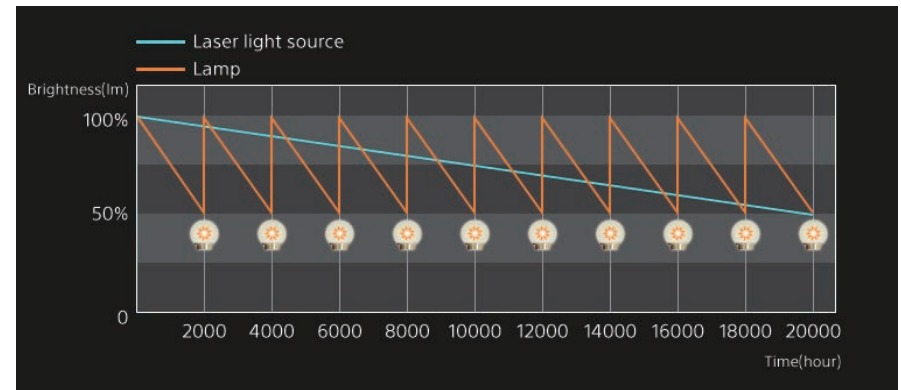

## Advanced crisp focused lens

---

Experience flawless clarity across the entire screen, thanks to our Advanced Crisp-Focused Lens. The 70-mm aspherical front lens widens the focus area, ensuring clear images from corner to corner. A floating focus system utilises two moving lens groups and extra-low dispersion glass for distortion-free images with accurate color reproduction.

\*BRAVIA Projector 8 only

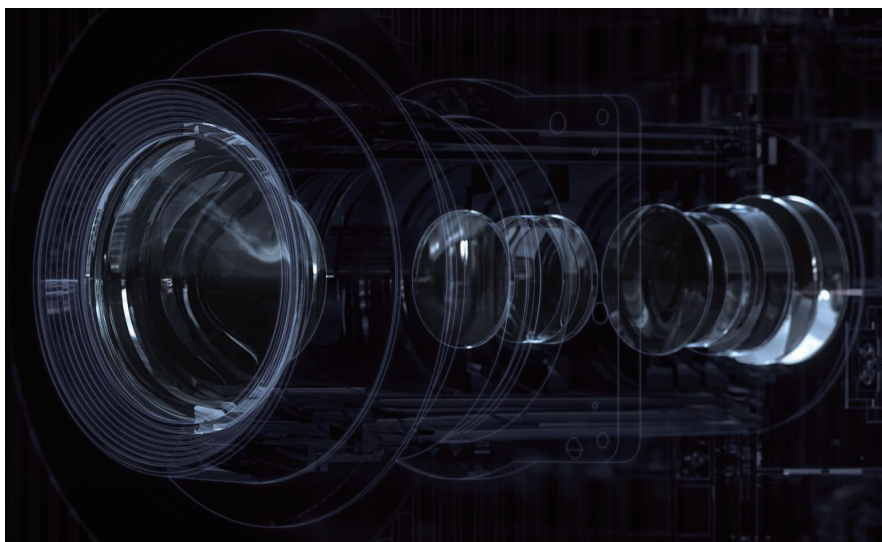

## Motorized zoom lens and wide lens shift

---

Installing your 4K laser projector in any room is easy with a motorized zoom and a wide lens shift range. Adjust the image position vertically and horizontally for the perfect setup whatever your room size.

## Advanced crisp focused lens

---

Experience flawless clarity across the entire screen, thanks to our Advanced Crisp-Focused Lens. The 70-mm aspherical front lens widens the focus area, ensuring clear images from corner to corner. A floating focus system utilises two moving lens groups and extra-low dispersion glass for distortion-free images with accurate color reproduction.

\*BRAVIA Projector 8 only

## BRAVIA Projector 8

VPL-XW6100ES

### CONNECTOR PANELS



#### Front

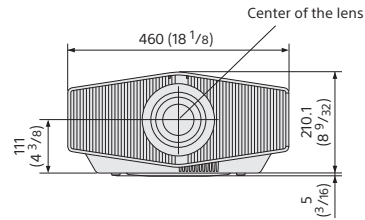

#### Bottom

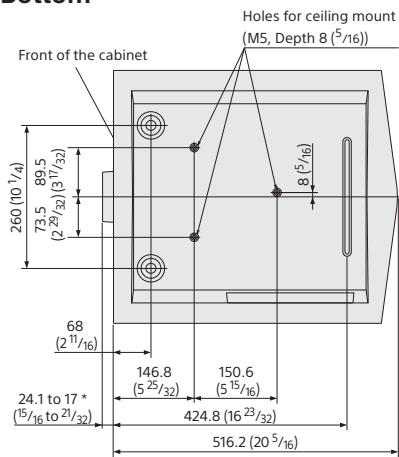

## VPL-XW5000ES

### CONNECTOR PANELS



#### Front

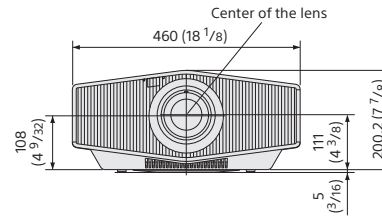

#### Bottom

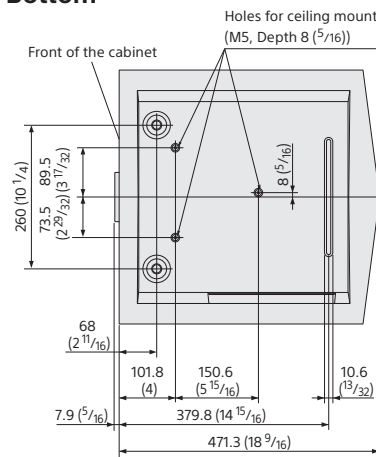

## VPL-GTZ380

### CONNECTOR PANELS

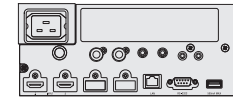

#### Front

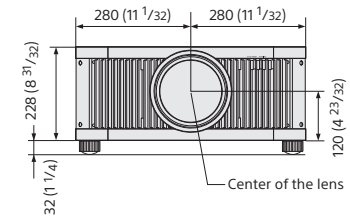

#### Bottom

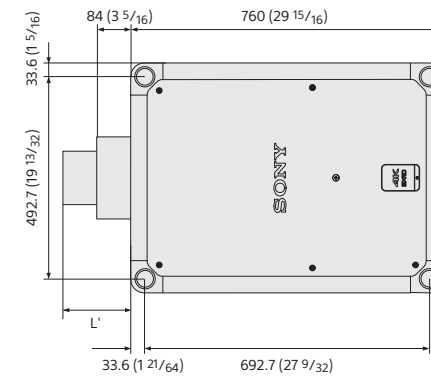

\*VPL-GTZ380  
 VPLL-Z8014 (Optional) : L' = 173 (6 13/16)  
 VPLL-Z8008 (Optional) : L' = Wide 184 (7 1/4) / Tele 175 (6 7/8)

\*BRAVIA Projector 8  
 Varies depending on how focus is adjusted.

Unit : mm (inches)

		BRAVIA Projector 8 VPL-XW6100ES	VPL-XW5000ES	VPL-GTZ380
Display system		4K SXRD panel, projection system	4K SXRD panel, projection system	4K SXRD panel, projection system
Display device	Size of effective display area	0.61" x 3	0.61" x 3	0.74" x 3
	Number of pixels	24,883,200 (3840 x 2160 x 3) pixels	24,883,200 (3840 x 2160 x 3) pixels	26,542,080 (4096 x 2160 x 3) pixels
Light output		2,700 lm	2,000 lm	10,000 lm
	Light source	Laser diode	Laser diode	Laser diode
Dynamic contrast		∞ : 1	∞ : 1	∞ : 1
Projection lens	Focus	Powered	Manual	Powered
	Zoom	Powered (Approx. x 2.1)	Manual (Approx. x 1.60)	Powered
	Lens shift	Powered, Vertical +/- 85 %, Horizontal +/- 36 %	Manual, Vertical +/- 71 %, Horizontal +/- 25 %	VPLL-Z8014 (Optional) : Powered, Vertical: +/- 80 %, Horizontal: +/- 33 % VPLL-Z8008 (Optional) : Powered, Vertical: +/- 50 %, Horizontal: +/- 19 %
	Throw ratio*1	1.35:1 to 2.84:1	1.38:1 to 2.21:1	VPLL-Z8014 (Optional) : 1.49 : 1 to 2.91 : 1 VPLL-Z8008 (Optional) : 0.85 : 1 to 1.09 : 1
		-	-	-
	Picture position memory	3	-	5
Picture processor		XR Processor for projector	X1 Ultimate for projector	X1 Ultimate for projector
	Contrast	XR Dynamic Tone Mapping XR Deep Black	Object-based HDR remaster Dynamic HDR Enhancer	Object-based HDR remaster Dynamic HDR Enhancer Digital Contrast Optimizer
	Color	XR Triluminos Pro	Triluminos Pro	Triluminos Pro
	Clarity	XR Clear Image	Object-based Super Resolution Dual Database Processing Digital Focus Optimizer	Object-based Super Resolution Dual Database Processing Digital Focus Optimizer
	Motion	Motionflow	Motionflow	Motionflow
Accepted HDR format		HDR10/HLG	HDR10/HLG	HDR10/HLG
Accepted digital signals		720x576/50p, 720x480/60p, 1280x720/50p, 1280x720/60p, 1920x1080/50i, 1920x1080/60i, 1920x1080/24p, 1920x1080/48p, 1920x1080/50p, 1920x1080/60p, 1920x1080/100p, 1920x1080/120p, 3840x2160/24p, 3840x2160/25p, 3840x2160/30p, 3840x2160/48p, 3840x2160/50p, 3840x2160/60p, 3840x2160/100p, 3840x2160/120p, 4096x2160/24p, 4096x2160/25p, 4096x2160/30p, 4096x2160/48p, 4096x2160/50p, 4096x2160/60p, 4096x2160/100p, 4096x2160/120p	720 x 576/50p, 720 x 480/60p, 1280 x 720/50p, 1280 x 720/60p, 1920 x 1080/50i, 1920 x 1080/60i, 1920 x 1080/24p, 1920 x 1080/50p, 1920 x 1080/60p, 1920 x 1080/120p, 3840 x 2160/24p, 3840 x 2160/25p, 3840 x 2160/30p, 3840 x 2160/48p, 3840 x 2160/50p, 3840 x 2160/60p, 3840 x 2160/100p, 3840 x 2160/120p, 4096 x 2160/24p, 4096 x 2160/25p, 4096 x 2160/30p, 4096 x 2160/48p, 4096 x 2160/50p, 4096 x 2160/60p	720 x 576/50p, 720 x 480/60p, 1280 x 720/50p, 1280 x 720/60p, 1920 x 1080/50i, 1920 x 1080/60i, 1920 x 1080/24p, 1920 x 1080/50p, 1920 x 1080/60p, 1920 x 1080/100p, 3840 x 2160/24p, 3840 x 2160/25p, 3840 x 2160/30p, 3840 x 2160/50p, 3840 x 2160/60p, 3840 x 2160/100p, 3840 x 2160/120p, 4096 x 2160/24p, 4096 x 2160/25p, 4096 x 2160/30p, 4096 x 2160/48p, 4096 x 2160/50p, 4096 x 2160/60p, WUXGA/60p, QXGA/60p, QXGA/120p, WQHD/60p, WQHD/120p, WQXGA/60p, WQXGA/120p
3D		-	-	Yes
Input Output (Computer / Video / Control)	HDMI	x 2 (HDMI2.1/HDCP2.3)	x 2 (HDMI2.0/HDCP2.3)	x 2 (HDMI2.0/HDCP2.3)
	Display Port	-	-	x 2 (HDCP2.3)
	Trigger	x 1 (Mini jack, DC 12 V, Max. 100 mA)	x 1 (Mini jack, DC 12 V, Max. 100 mA)	x 2 (Mini jack, DC 12 V, Max. 100 mA)
	RS-232C	x 1 (D-sub 9-pin (male))	x 1 (D-sub 9-pin (male))	x 1 (D-sub 9-pin (male))
	LAN	x 1 (RJ-45, 10BASE-T/100BASE-TX)	x 1 (RJ-45, 10BASE-T/100BASE-TX)	x 1 (RJ-45, 10BASE-T/100BASE-TX)
	IR IN / OUT	IN: x 1 (Mini jack)	IN: x 1 (Mini jack)	IN: x 1, Out: x 1 (Mini jack)
	3D SYNC OUT	-	-	x 1 (3-pin mini-DIN (VESA 3D))
	USB (for Firmware update)	x 1 (Type A, DC 5 V, Max. 500 mA)	x 1 (Type A, DC 5 V, Max. 500 mA)	x 1 (Type A, DC 5 V, Max. 500 mA)
Acoustic noise*2		26 dB	24 dB	33-39 dB
Power requirements		AC 100-240 V, 50/60 Hz	AC 100-240 V, 50/60 Hz	AC 200-240 V, 50/60 Hz, AC 100-120 V, 50/60 Hz (Brightness is dimmed.)
Power consumption		380 W	295 W	Max. 2.0 kW (TBD)
	Standby	0.3 W (when "Remote Start" is set to "Off")	0.3 W (when "Remote Start" is set to "Off")	0.4 W (when "Remote Start" is set to "Off")
	Networked Standby	0.5 W (LAN) (when "Remote Start" is set to "On") When a LAN terminal is not connected, it becomes a low power consumption mode (0.4 W)	0.5 W (LAN) (when "Remote Start" is set to "On") When a LAN terminal is not connected, it becomes a low power consumption mode (0.4 W)	1.0 W (LAN) (when "Remote Start" is set to "On")
Dimensions (Without Protrusions)		W 460 x H 210 x D 517 mm (W 18 1/8 x H 8 9/32 x D 20 11/32 in)	W 460 x H 200 x D 472 mm (W 18 1/8 x H 7 7/8 x D 18 19/32 in)	W 560 x H 228 x D 760 mm (W 22 1/16 x H 8 31/32 x D 29 15/16 in)
Mass		Approx. 14 kg / 31 lb	Approx. 13 kg / 28 lb	Approx. 51 kg / 112 lb.
Supplied accessories		Remote Control (RM-PJ24), Size AA (R6/LR6) batteries (2), AC Power Cord (1), Lens Cap (1), Setup Guide (1)	Remote Control (RM-PJ28), Size AA (R6/LR6) batteries (2), AC Power Cord (1), Lens Cap (1), Setup Guide (1)	RM-PJ29 Remote Commander (1), Size AA (R6/LR6) batteries (2), AC power Cord (1), Lens Cap (1), Plug holder (1), Safety Regulations (1)
Optional accessories		-	-	VPLL-Z8014 (Normal throw lens) VPLL-Z8008 (Short throw lens)

\*1 Display size : 16:9

\*2 Depends on the projector setting condition and usage environment.

# SONY

Distributed by

©2024 Sony Corporation. All rights reserved.

Reproduction in whole or in part without written permission is prohibited.

Features, design, and specifications are subject to change without notice.

The values for mass and dimension are approximate.

Some images in this brochure are simulated.

"SONY" is a registered trademark of Sony Corporation.

"Z-Phosphor", "TRILUMINOS" and "Remote Commander" are trademarks of Sony Corporation.

SXRD is a registered trademark or a trademark of Sony Group Corporation or its affiliates.

IMAX® is a registered trademark of IMAX Corporation in the United States and/or other countries.

All Rights Reserved.

The terms HDMI and HDMI High-Definition Multimedia Interface, and the HDMI Logo are trademarks

or registered trademarks of HDMI Licensing LLC in the United States and other countries.

All other trademarks are the property of their respective owners.

Please visit Sony's professional website or contact your Sony representative for specific models available in your region.