

# SONY

## VPL-VW5000ES

The World's Most Advanced 4K Home Theater Projector  
5000lm with Laser Light Source



4K



# The world's Most Advanced Home Cinema Projector:

## Spectacular Brightness and Native 4K Clarity

It's an unforgettable experience, whatever you're watching.

An ideal match for the largest and most lavishly equipped home cinema rooms, the VPL-VW5000ES brings movies to life with extraordinary cinematic detail, color and contrast.

The world's most advanced home cinema projector combines an advanced laser light source with the same Sony 4K SXRD panel technology that's found in our professional cinema projectors.

Crisply detailed native 4K images (4096 x 2160) offer four times the resolution of Full HD, pulling you right into the heart of the action with unprecedented clarity.

You'll experience fabulously rich cinematic colors, smooth motion and spectacular contrast.

Extremely powerful 5000 lumen brightness ensures wonderfully clear and sharp big-screen pictures, even in well-lit rooms.

The ultra-pure, highly efficient laser light source provides virtually maintenance free operation with no lamp swaps. As well as spectacular picture quality and reliability, you'll enjoy reduced operating costs compared with conventional projection systems, plus less worry of lamp failure half way through the show. You're fully prepared with compatibility for the latest 4K standards, including High Frame Rates and HDR (High Dynamic Range) - so you'll get the very best out of today's content, and tomorrow's.

With flexible installation, simple setup, fuss-free auto calibration and low-noise operation, the VPL-VW5000ES 4K Home Cinema Projector puts you in control of the ultimate entertainment experience.



# Breathtaking Picture Quality

## Real-life clarity with Cinematic 4K - over four times the detail of Full HD

With more than four times the resolution of Full HD, 4K offers 8.8 million pixels for a picture that's so incredibly lifelike, you could believe you're looking at the real thing. Every detail is perfectly clear, with less jagged edges and visible pixels than with a conventional Full HD projector.

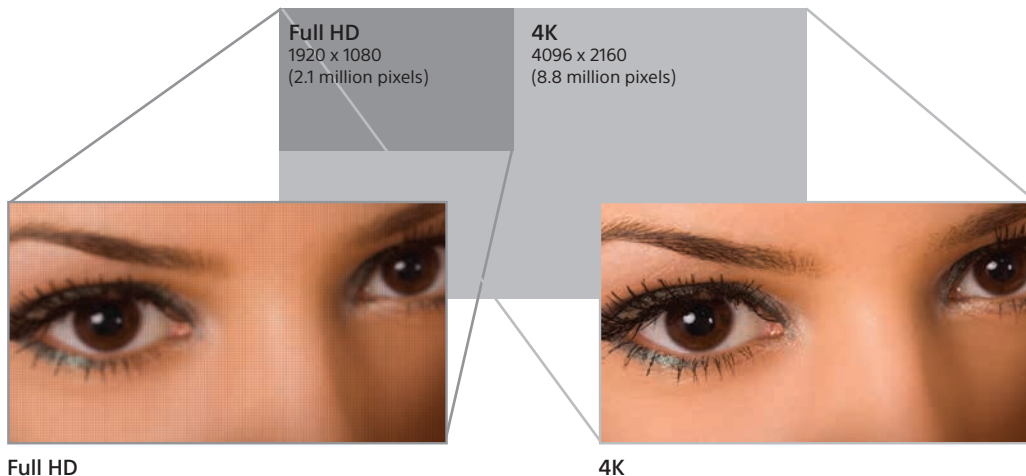

Simulated images

## Very high brightness and contrast

With an impressive 5,000 lumen brightness and a spectacularly high contrast range, 4K images are clear and bright with sparkling highlights and rich, deep blacks – even in well-lit rooms.



Standard Home Theater Projector  
Not bright enough



VPL-VW5000ES  
Images are brighter and clearer  
even in a well-lit environment

Simulated images

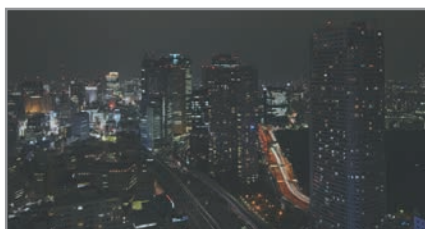

Standard Projector



VPL-VW5000ES

Simulated images

## Long-lasting laser light source

Inside the VPL-VW5000ES is an ultra-pure, reliable laser light source with Z-Phosphor technology.

## HDR Compatible

Complies with High Dynamic Range (HDR), enabling the full range of each image to be viewed accurately and clearly.



Standard Dynamic Range



High Dynamic Range

Simulated images

## Reality Creation: Upscale Your Movies to 4K

As well as native 4K material, you can watch your current Full HD Blu-ray™ or DVD movie collection upscaled for a 4K experience. Reality Creation is a super-resolution technology that radically enhances Full HD content, even upscaling 3D movies for 4K.

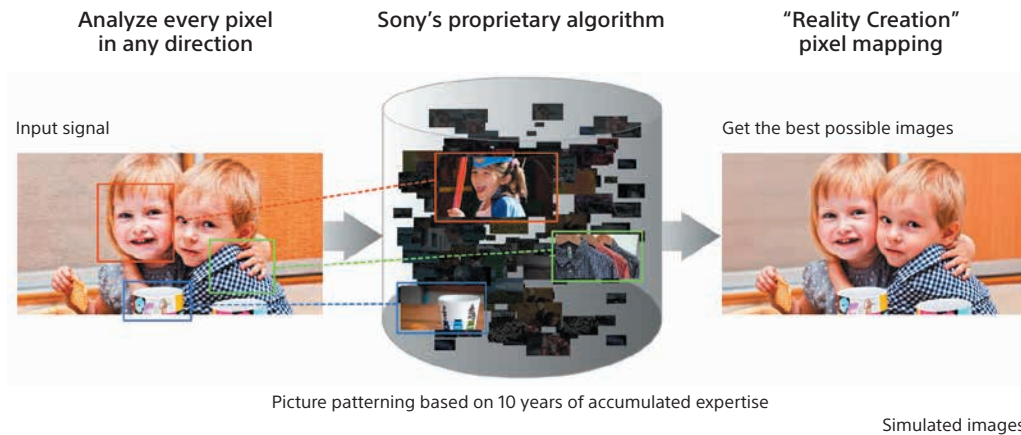

## Motionflow

We've simplified our Motionflow offering. Combination mode uses Sony's Film Projection and Motion Enhancer capabilities, adding frames to reduce blur and maintain brightness in thrilling, fast-moving scenes. Cinema purists can choose True Cinema mode to retain the original 24 fps.

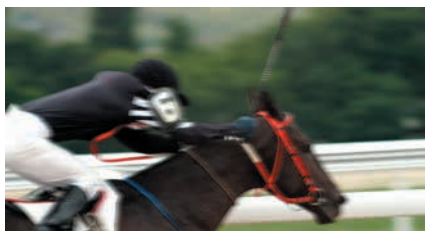

Without Motionflow



With Motionflow

Simulated images

## TRILUMINOS™ Display with even wider, cinema-like color gamut

You will enjoy an extended range of spectacular colors, far wider than a standard projection system. The VPL-VW5000ES supports the same DCI-P3 color space as professional cinema projectors, as well as the new BT.2020 color space (emulated) that accurately captures an even wider range of true-to-life tones.



Simulated images

# Installation Advantages

## Wider Zoom and Shift Lens

The projector offers a powered lens for zoom, shift and focus to provide maximum flexibility for home installations, including high ceiling mounting.

## One-way Air Flow and Liquid Cooling System with Low Noise Operation

With an advanced air discharge system, the VPL-VW5000ES is very quiet during operation, 35dB or lower, even though it's a high brightness projector.

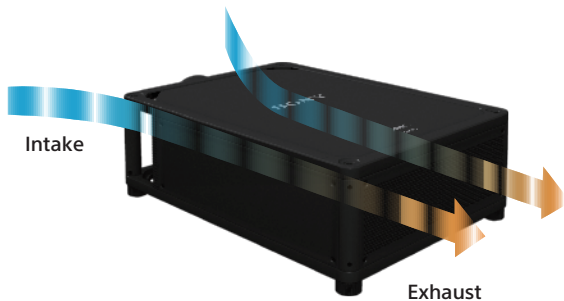

Liquid Cooling

## Picture Position Memory Matches Movie Aspect Ratio

The projector has a picture position memory, which memorizes the position of the lens (focus, zoom, shift). Users can match a movie's aspect ratio, including 1.78:1 and 2.35:1, and store these settings in the projector for easy recall.

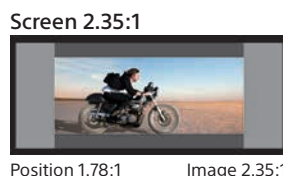

2.35:1 without picture position memory

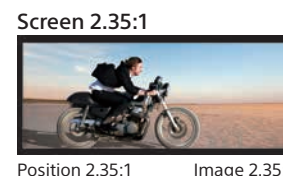

2.35:1 with picture position memory

Simulated images

# User-friendly Functions

## Quick turn On/Off

The laser projector can be turned on and off quickly.

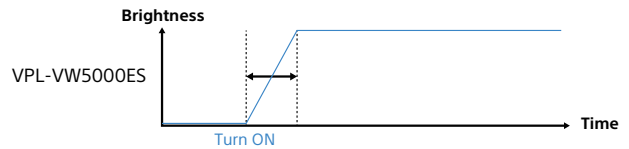
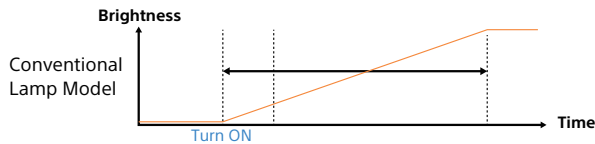

## Built-in Auto Calibration

After extended periods, color can be automatically calibrated to the original factory condition. There's no need for extra calibration equipment or cameras; a built-in color sensor stores all the necessary information.

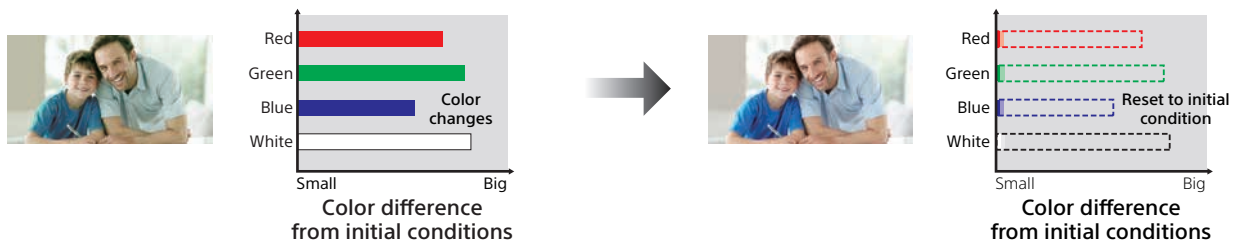

## Long-life Optics

Deliver up to 20,000 hours of operation with virtually zero maintenance. (up to 40,000h in low brightness mode)

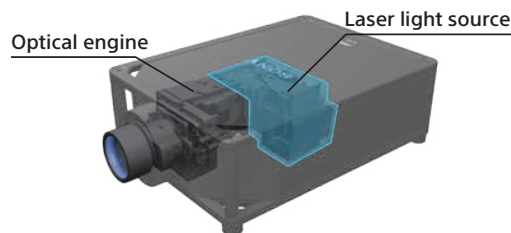

## Dust resistance by sealed optics

All optical components from lens to light source are sealed, avoiding dust accumulation.

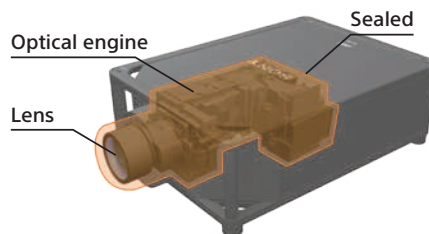

## The Latest 4K/60p HDMI Standard: 60 Frames Per Second

The projectors can show up to 60 frames per second in 4K (at color signal YCbCr 4:4:4 8bit / YCbCr 4:2:2 12bit). It's the new 4K industry standard and is much higher than the earlier 24p. The result is a smoother image with superior color and realism.

## USB Updates

To get the best from your projector, there's a USB port for the latest firmware updates.



## Low Latency Mode

A new feature for gamers. Experience our fastest ever response time between your controller and the screen for ultimate gaming action.

## Easy Connectivity for Home Automation

Complies with many home automation systems via an RJ45(IP), RS-232C, TRIGGER and IR IN interfaces.

## COMPATIBLE LENSES

Projection lens	VPLL-Z7008 (Optional)	VPLL-Z7013 (Bundled)
		
Throw ratio	0.80:1 to 1.02:1	1.27:1 to 2.73:1
Zoom / Focus	Powered/Powered	Powered/Powered
Lens shift	Powered, Vertical: +/- 50 %, Horizontal: +/- 18 %	Powered, Vertical: +/- 80 %, Horizontal: +/- 31 %
Aperture	f/2.9	f/2.9 to 3.9
Screen size*	60" to 1000"	60" to 300"
Dimensions	Wide W 5 9/32 x H 5 5/32 x D 12 5/32 in (W 134 x H 131 x D 309 mm) Tele W 5 9/32 x H 5 5/32 x D 11 5/32 in (W 134 x H 131 x D 283 mm)	W 5 5/32 x H 5 5/32 x D 9 29/32 in (W 131 mm x H 131 mm x D252 mm)
Weight	8.2 lb / 3.7 kg	5.7 lb / 2.6 kg

## DIMENSIONS

Unit: inches (mm)

### Front

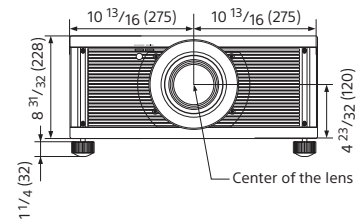

### Top

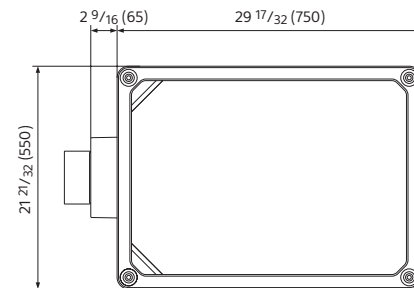

### Bottom

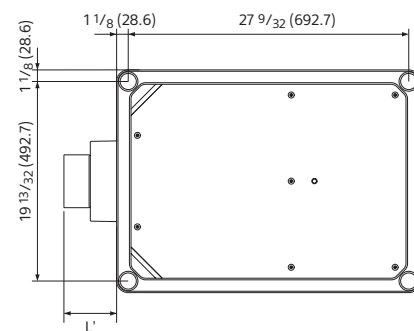

The distance L' is between the front of the lens (center) and the front of the cabinet.

Unit: inches (mm)

Lens	L'
VPLL-Z7008 (Optional)	Wide 7 9/32 (185.2) / Tele 6 1/4 (159.0)
VPLL-Z7013 (Bundled)	5 1/8 (130.2)

## OPTIONAL ACCESSORIES



TDG-BT500A  
3D Glasses

## CONNECTOR PANELS

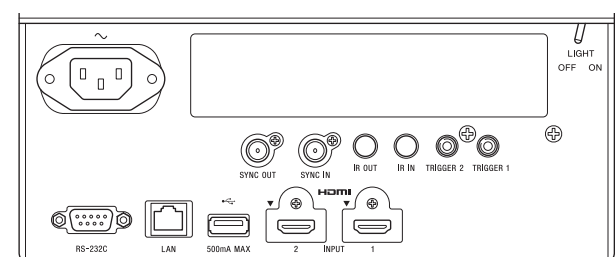

# SPECIFICATIONS

		VPL-VW5000ES
Display System		4K SXRD panel, projection system
Display device	Size of effective display area	0.74" x 3
	Number of pixels	26,542,080 (4096 x 2160 x 3) pixels
Projection lens	Focus	Powered
	Zoom	Powered
	Lens shift	VPLL-Z7013 (Bundled) : Powered, Vertical: +/-80 %, Horizontal: +/-31 % VPLL-Z7008 (Optional) : Powered, Vertical: +/-50 %, Horizontal: +/-18 %
	Throw ratio	VPLL-Z7013 (Bundled) : 1.27 : 1 to 2.73 : 1 VPLL-Z7008 (Optional) : 0.80 : 1 to 1.02 : 1
	Screen size	VPLL-Z7013 (Bundled): 60" to 300" (1,524 mm to 7,620 mm) VPLL-Z7008 (Optional): 60" to 1000" (1,524 mm to 25,400 mm)
Light source	Laser diode	
Filter replacement cycle (Max.)		20,000 H
Light output		5,000 lm
Color light output		5,000 lm
Contrast ratio		∞ : 1 (dynamic contrast)
Accepted digital signals*1		VGA, SVGA, XGA, WXGA(1280x768), Quad-VGA, SXGA, 720x480/60p, 720x576/50p, 1280x720/50p, 1280x720/60p, 1920x1080/50i,1920x1080/60i, 1920x1080/24p, 1920x1080/50p, 1920x1080/60p, 3840x2160/24p, 3840x2160/25p, 3840x2160/30p, 3840x2160/50p, 3840x2160/60p, 4096x2160/24p, 4096x2160/25p, 4096x2160/30p, 4096x2160/50p, 4096x2160/60p
Color bit depth		Up to 12 bit via HDMI
INPUT OUTPUT (Computer / Video / Control)	HDMI1 / HDMI2*2	Digital (RGB/Y Pb/Cb Pr/Cr)
	Trigger1 / Trigger2	Minijack, DC 12 V Max. 100 mA
	Remote	RS-232C, D-sub 9-pin (female)
	LAN	RJ45, 10BASE-T/100BASE-TX
	IR IN / OUT	IN:1, Out:1 , Mini jack
	SYNC	IN:1, Out:1
	USB	Type A
OSD language		18-languages (English, Dutch, French, Italian, German, Spanish, Portuguese, Turkish, Russian, Swedish, Norwegian, Japanese, Simplified Chinese, Traditional Chinese, Korean, Thai, Arabic, Polish)
Acoustic noise		30 dB ~ 35 dB*3
Operating temperature / Operating humidity		41°F to 104°F (5°C to 40°C) / 20% to 80% (no condensation)
Storage temperature / Storage humidity		14°F to +140°F (-10°C to +60°C) / 20% to 80% (no condensation)
Power requirements		AC 220 V to 240 V, 6 A, 50/60 Hz (For Europe and China) AC 100 V to 240 V, 12 A to 6 A, 50/60 Hz (For the other countries)
Power consumption		MAX. 1.2 kW
Power consumption (Standby Mode)		0.4 W (When "Remote Start" is set to "Off")
Power consumption (Networked Standby Mode)		0.6 W (LAN) (When "Remote Start" is set to "On")
Heat dissipation		4092 BTU/h
Dimensions	excluding lens (Without Protrusions)	W 21 21/32 x H 8 31/32 x D 29 17/32 in (W 550 x H 228 x D 750 mm)
	including VPLL-Z7013 (Bundled)	W 21 21/32 x H 10 5/16 x D 34 21/32 in (W 550 x H 262 x D 880 mm)
Weight	excluding lens	Approx. 88 lbs 3 oz (40 kg)
	including VPLL-Z7013 (Bundled)	Approx. 94 lbs 13oz (43 kg)
Supplied accessories		RM-PJ24 Remote Commander (1), Size AA (R6) Manganese Batteries (2), AC Power Cord (1), Operating Instructions (CD-ROM) (1), Quick Reference Manual (1)
Optional accessories		VPLL-Z7008 (Short throw lens), TDG-BT500A (3D glass)

\*1 60p,30p,24p include 59.94/60Hz, 29.97Hz/30Hz, 23.98Hz/24Hz

\*2 Both HDMI inputs are compatible with HDCP 2.2.

\*3 They will depend on the environment or how the projectors is used. When under normal environment.

LASER NOTICES  
IEC 60825-1:2007



IEC 60825-1:2014

CLASS 1 LASER PRODUCT  
RISK GROUP 2 to IEC 62471:2006  
Caution: Possibly hazardous optical radiation emitted from this product.



Distributed by

©2016 Sony Corporation. All rights reserved.  
Reproduction in whole or in part without written permission is prohibited.  
Features and specifications are subject to change without notice.  
The values for weight and dimension are approximate.  
"SONY", "3D World", "TRILUMINOS", "Z-Phosphor", "SXRD" and "Remote Commander" are trademarks of Sony Corporation.  
The terms HDMI and HDMI High-Definition Multimedia Interface, and the HDMI Logo are trademarks or registered trademarks of HDMI Licensing LLC in the United States and other countries.  
All other trademarks are the property of their respective owners.